

ecobike



# *E-BIKE CATALOGUE*



# TABLE OF CONTENTS

## MTB

SX Youth White	6
SX Youth Blue	8
SX 3	10
SX 4	12
SX 5	14
SX 300 Cool Gray	16
SX 300 Sandstorm	18
RX 500	20
Mauler	22

## SUV

Expedition Yellow	26
Expedition Midnight Black	28

## TREKKING

Forest	32
D1 Trekking	34
X-Cross White	36
X-Cross Black	38
X-Cross M	40
LX	42
MX	44
LX 300 White Rose	46
MX 300 Green	48
LX 500 Mint	50
LX 500 Palm Blue	52
MX 500 Blue	54

## CITY

Urban	58
X-City Coffee	60
X-City Cappuccino	62
D2 City Menthol	64
D2 City Black	66
Cargo	78
Basic Black	70
Basic Petrol Blue	72
Basic Nexus White	74
Basic Nexus Blue	76
Traffic Black	80
Traffic White	82
Traffic Beige	84
Traffic Navy Blue	86
Traffic Mint	88
Traffic Blue	90
Traffic M Black	92
Even Black	96
Even White	98
Even Ocean Blue	100
Rhino	102

# HOW IT WORKS?

Ecobike e-bikes are supported by efficient and reliable electric motors. Depending on the model, motors are located in either rear or front wheel hub, or centrally (mid-drive motors).

The drive system is powered by a lithium-ion battery located in the frame or on the trunk.

Intuitive displays are used to control the driving assistance. They also provide users with different additional function which vary from one model to another.

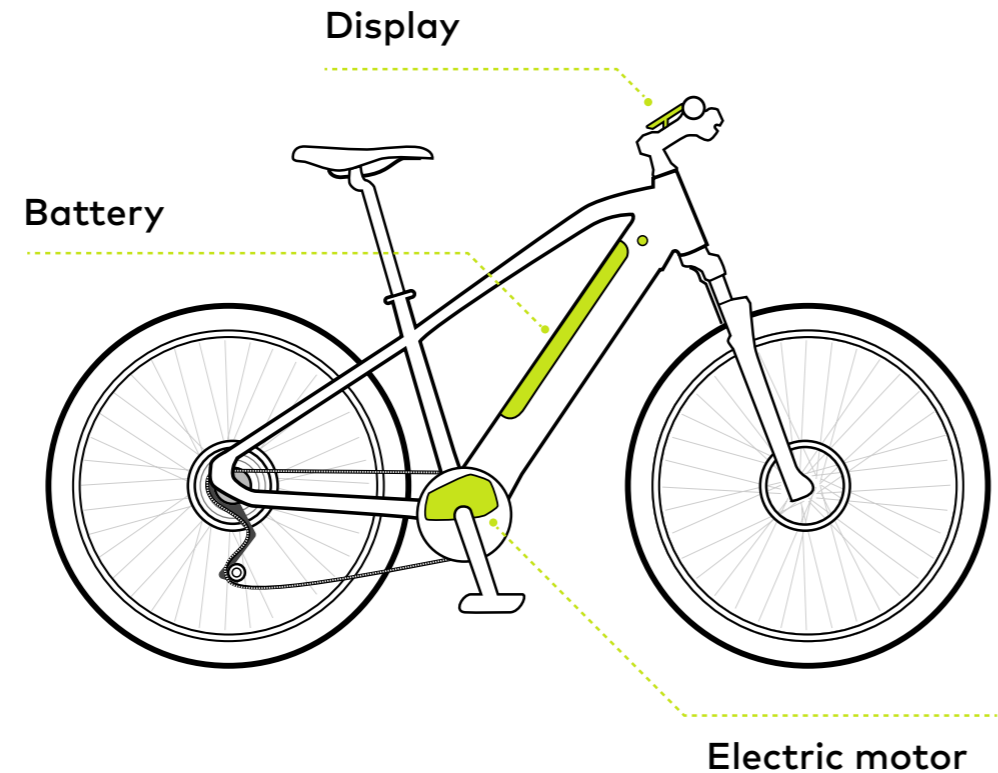

SCHEME OF A TYPICAL E-BICYCLE WITH MID-DRIVE MOTOR AND BATTERY IN FRAME

## Good to know



### Bike weight (kg)

Total weight of the bike including all components, engine and battery. Our frames are made using light aluminium alloys, which translates into their relatively low weight



### Torque

The torque of an electric motor determines its capabilities in relation to the terrain's features. It is responsible for acceleration, the bike's pulling power, and making it easier to climb hills



### Motor-assisted driving

The engine starts automatically in response to the movement of the bicycle crank and stops if the sensors do not detect pedaling by the user



### Battery capacity (Wh)

This value is expressed in Watt-hours for the bike range that can be covered using a fully charged battery



### Maximum range (km)

Maximum route length can be traveled on single battery charge. The distance depends on the rider's weight, terrain and the level of driving assistance



### Classic driving

Every Ecobike model is also a well-equipped bike. You can use an e-bike in a standard way with the motor turned off. It does not differ from a traditional bike ride

# MTB MOUNTAIN E-BIKES

Here the real adventure begins!  
Whenever the asphalt ends and the  
road becomes unpredictable, there is no  
room for experiments. You need a bike  
you can rely on. Meet our excellent  
mountain e-bikes with powerful  
rear-mounted and mid-drive motors.



**ECOBIKE**



**#READY  
FOR  
ADVENTURE**

ECOBIKE MTB

# SX Youth White



Discover more

- 22.9 kg**  
Weight
- 250 W**  
Motor power
- 522 Wh**  
Battery capacity
- 110 km**  
Maximum range
- 26"**  
Wheel
- 14"**  
Frame

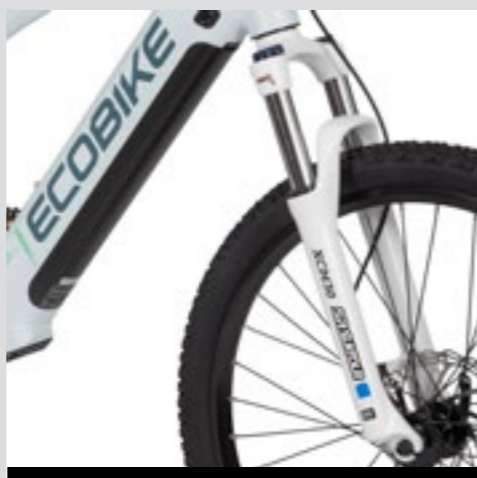
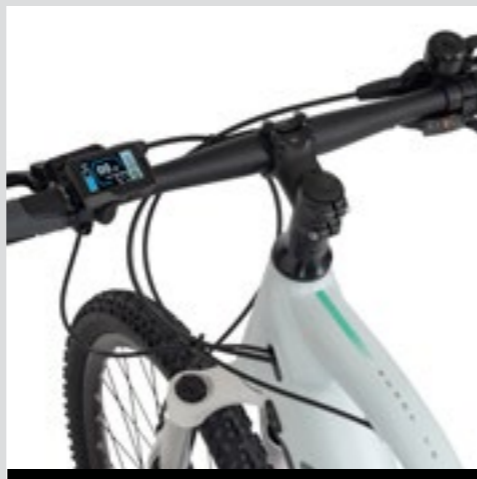

Specification

<b>Frame</b>	14" hydroformed aluminium
<b>Fork</b>	SunTour XCM travel 100 mm
<b>Wheel</b>	26" reinforced three-chambered rims / Sapim spokes
<b>Tires</b>	26" x 2.1 Rubena Ocelot
<b>Derailleur front</b>	-
<b>Derailleur rear</b>	Shimano Alivio 9-speed
<b>Shifter</b>	Shimano Altus 9-speed
<b>Brakes</b>	Alhonga HJ-HT472 hydraulic
<b>Saddle</b>	Velo VL-4457
<b>Handlebar</b>	Zoom 700 mm 31.8
<b>Handlebar stem</b>	Promax 0-40° / 60 mm
<b>Freewheel / Cassette</b>	Shimano CS-HG200-9 11-36T 9-speed
<b>Chain</b>	KMC
<b>Crank</b>	Prowheel Pioneer 152 mm
<b>Front hub</b>	Modus
<b>Rear hub</b>	Modus
<b>Bottom bracket</b>	Feimin FP-B902W
<b>Pedals</b>	VP
<b>Grip</b>	Velo VLG-776
<b>Front light</b>	-
<b>Rear light</b>	-
<b>Seat post</b>	Promax 27.2 / 300 mm
<b>Max load</b>	125 kg
<b>Weight</b>	22.9 kg

<b>Type of motor</b>	Rear hub motor
<b>Brand of motor</b>	Bafang
<b>Model of motor</b>	SWX02-C
<b>Nominal power of motor</b>	250 W

<b>Torque</b>	45 N.m
<b>Voltage</b>	36 V

<b>Type of battery</b>	Li-ion
<b>Battery power</b>	522 Wh
<b>Voltage</b>	36 V
<b>Range</b>	up to 110 km
<b>Cells brand</b>	Greenway

<b>Display</b>	Color LCD
<b>Display brand</b>	Ecobike
<b>Display model</b>	KD-386

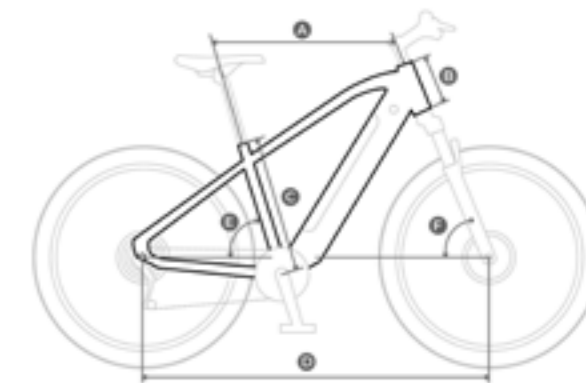

- A 569.9 mm
- B 160 mm
- C 356 mm
- D 1068 mm
- E 74.5°
- F 69°







E-bike system



ECOBIKE MTB  
**SX Youth Blue**



Discover more

-  **22.9 kg**  
Weight
-  **250 W**  
Motor power
-  **522 Wh**  
Battery capacity
-  **110 km**  
Maximum range
-  **26"**  
Wheel
-  **14"**  
Frame

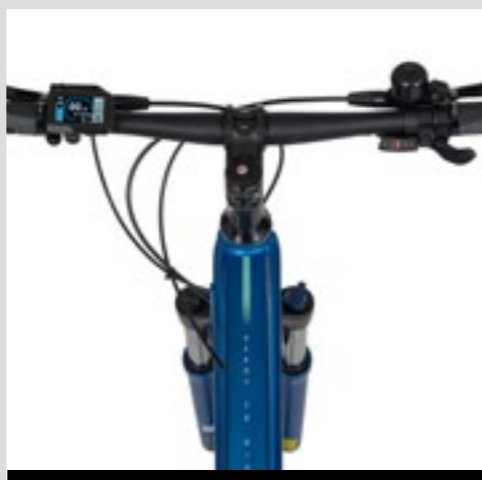

Specification

<b>Frame</b>	14" hydroformed aluminium
<b>Fork</b>	SunTour XCM travel 100 mm
<b>Wheel</b>	26" reinforced three-chambered rims / Sapim spokes
<b>Tires</b>	26" x 2.1 Rubena Ocelot
<b>Derailleur front</b>	-
<b>Derailleur rear</b>	Shimano Alivio 9-speed
<b>Shifter</b>	Shimano Altus 9-speed
<b>Brakes</b>	Alhonga HJ-HT472 hydraulic
<b>Saddle</b>	Velo VL-4457
<b>Handlebar</b>	Zoom 700 mm 31.8
<b>Handlebar stem</b>	Promax 0-40° / 60 mm
<b>Freewheel / Cassette</b>	Shimano CS-HG200-9 11-36T 9-speed
<b>Chain</b>	KMC
<b>Crank</b>	Prowheel Pioneer 152 mm
<b>Front hub</b>	Modus
<b>Rear hub</b>	Modus
<b>Bottom bracket</b>	Feimin FP-B902W
<b>Pedals</b>	VP
<b>Grip</b>	Velo VLG-776
<b>Front light</b>	-
<b>Rear light</b>	-
<b>Seat post</b>	Promax 27.2 / 300 mm
<b>Max load</b>	125 kg
<b>Weight</b>	22.9 kg

<b>Type of motor</b>	Rear hub motor
<b>Brand of motor</b>	Bafang
<b>Model of motor</b>	SWX02-C
<b>Nominal power of motor</b>	250 W

<b>Torque</b>	45 N.m
<b>Voltage</b>	36 V

<b>Type of battery</b>	Li-ion
<b>Battery power</b>	522 Wh
<b>Voltage</b>	36 V
<b>Range</b>	up to 110 km
<b>Cells brand</b>	Greenway

<b>Display</b>	Color LCD
<b>Display brand</b>	Ecobike
<b>Display model</b>	KD-386

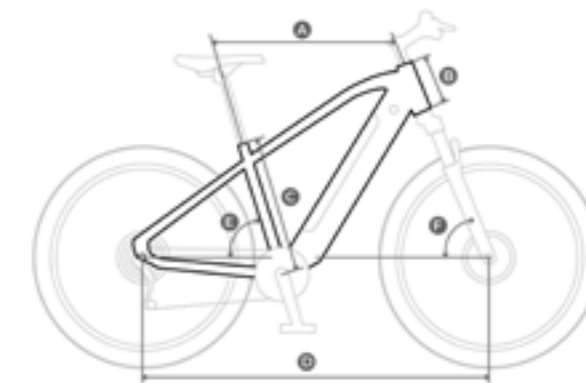

- A** 569.9 mm
- B** 160 mm
- C** 356 mm
- D** 1068 mm
- E** 74.5°
- F** 69°



ECOBIKE MTB

# SX 3



Discover more

- 25 kg**  
Weight
- 250 W**  
Motor power
- 522 – 630 Wh**  
Battery capacity
- 140 km**  
Maximum range
- 27.5"**  
Wheel
- 17"**  
Frame



## Specification

<b>Frame</b>	17" hydroformed aluminium
<b>Fork</b>	SunTour XCM travel 100 mm
<b>Wheel</b>	27.5" reinforced three-chambered rims / Sapim spokes
<b>Tires</b>	27.5" x 2.125 TRC Dryjack
<b>Derailleur front</b>	Shimano Altus 3-speed
<b>Derailleur rear</b>	Shimano Alivio 9-speed
<b>Shifter</b>	Shimano Altus 3 x 9
<b>Brakes</b>	Alhonga HJ-HT472 hydraulic
<b>Saddle</b>	Velo VL-3363
<b>Handlebar</b>	Zoom 720 mm 31.8
<b>Handlebar stem</b>	Promax 10° / 90 mm
<b>Freewheel / Cassette</b>	Skilful 13-32T 9-speed
<b>Chain</b>	KMC X9
<b>Crank</b>	Shimano FCM371 44 x 32 x 22
<b>Front hub</b>	KT-K68F
<b>Rear hub</b>	Motor
<b>Bottom bracket</b>	Feimin FP-B902W
<b>Pedals</b>	Velo
<b>Grip</b>	Velo VLG-776
<b>Front light</b>	-
<b>Rear light</b>	-
<b>Seat post</b>	Promax 27.2 / 350 mm
<b>Max load</b>	125 kg
<b>Weight</b>	25 kg

<b>Type of motor</b>	Rear hub motor
<b>Brand of motor</b>	Bafang
<b>Model of motor</b>	SWX02
<b>Nominal power of motor</b>	250 W

<b>Torque</b>	45 N.m
<b>Voltage</b>	36 V

<b>Type of battery</b>	Li-ion
<b>Battery power</b>	522 – 630 Wh
<b>Voltage</b>	36 V
<b>Range</b>	up 140 km
<b>Cells brand</b>	LG / Greenway

<b>Display</b>	Monochromatic LCD
<b>Display brand</b>	Ecobike
<b>Display model</b>	C300U

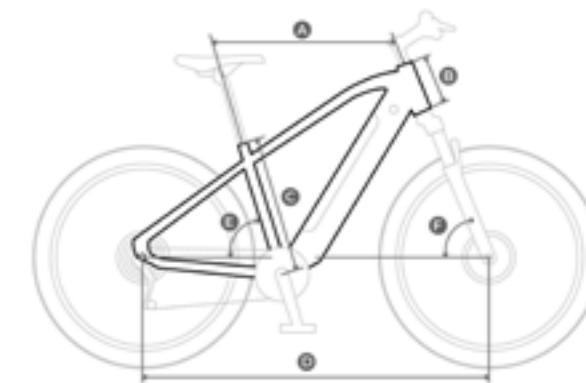

- A** 585 mm
- B** 160 mm
- C** 432 mm
- D** 1085.7 mm
- E** 73°
- F** 70°



## E-bike system

ECOBIKE MTB

# SX 4



25.3 kg

Weight



250 W

Motor power



522 – 630 Wh

Battery capacity



140 km

Maximum range



27.5"

Wheel



19"

Frame



Discover more



Specification

<b>Frame</b>	19" hydroformed aluminium
<b>Fork</b>	SunTour XCM travel 100 mm
<b>Wheel</b>	27.5" reinforced three-chambered rims / Sapim spokes
<b>Tires</b>	27.5" x 2.125 TRC Dryjack
<b>Derailleur front</b>	Shimano Altus 3-speed
<b>Derailleur rear</b>	Shimano Alivio 9-speed
<b>Shifter</b>	Shimano Altus 3 x 9
<b>Brakes</b>	Alhonga HJ-HT472 hydraulic
<b>Saddle</b>	Velo VL-3363
<b>Handlebar</b>	Zoom 720 mm 31.8
<b>Handlebar stem</b>	Promax 10° / 90 mm
<b>Freewheel / Cassette</b>	Skilful 13-32T 9-speed
<b>Chain</b>	KMC X9
<b>Crank</b>	Shimano FCM371 44 x 32 x 22
<b>Front hub</b>	KT-K68F
<b>Rear hub</b>	Motor
<b>Bottom bracket</b>	Feimin FP-B902W
<b>Pedals</b>	Velo
<b>Grip</b>	Velo VLG-776
<b>Front light</b>	-
<b>Rear light</b>	-
<b>Seat post</b>	Promax 27.2 / 350 mm
<b>Max load</b>	125 kg
<b>Weight</b>	25.3 kg

<b>Type of motor</b>	Rear hub motor
<b>Brand of motor</b>	Bafang
<b>Model of motor</b>	SWX02
<b>Nominal power of motor</b>	250 W

<b>Torque</b>	45 N.m
<b>Voltage</b>	36 V

<b>Type of battery</b>	Li-ion
<b>Battery power</b>	522 – 630 Wh
<b>Voltage</b>	36 V
<b>Range</b>	up 140 km
<b>Cells brand</b>	LG / Greenway

<b>Display</b>	Monochromatic LCD
<b>Display brand</b>	Ecobike
<b>Display model</b>	C300U

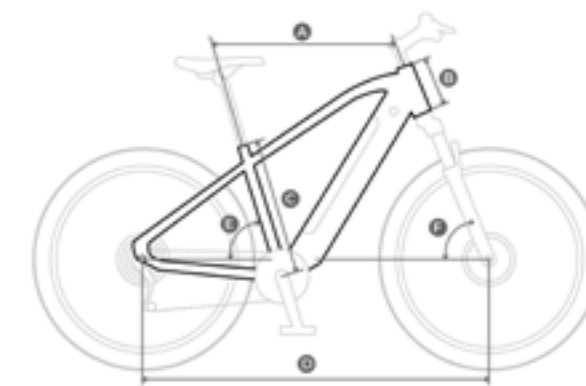

<b>A</b>	595 mm
<b>B</b>	160 mm
<b>C</b>	482 mm
<b>D</b>	1095.8 mm
<b>E</b>	73°
<b>F</b>	70°



E-bike system



ECOBIKE MTB

# SX 5



Discover more

- 25.8 kg**  
Weight
- 250 W**  
Motor power
- 522 – 630 Wh**  
Battery capacity
- 140 km**  
Maximum range
- 29"**  
Wheel
- 20"**  
Frame

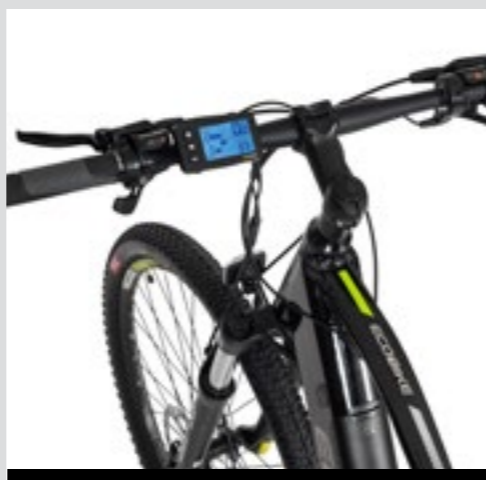

## Specification

<b>Frame</b>	20" hydroformed aluminium
<b>Fork</b>	SunTour XCM travel 100 mm
<b>Wheel</b>	29" reinforced three-chambered rims / Sapim spokes
<b>Tires</b>	29" x 2.125 TRC Dryjack
<b>Derailleur front</b>	Shimano Altus 3-speed
<b>Derailleur rear</b>	Shimano Alivio 9-speed
<b>Shifter</b>	Shimano Altus 3 x 9
<b>Brakes</b>	Alhonga HJ-HT472 hydraulic
<b>Saddle</b>	Velo VL-3363
<b>Handlebar</b>	Zoom 720 mm 31.8
<b>Handlebar stem</b>	Promax 10° / 90 mm
<b>Freewheel / Cassette</b>	Skilful 13-32T 9-speed
<b>Chain</b>	KMC X9
<b>Crank</b>	Shimano FCM371 44 x 32 x 22
<b>Front hub</b>	KT-K68F
<b>Rear hub</b>	Motor
<b>Bottom bracket</b>	Feimin FP-B902W
<b>Pedals</b>	Velo
<b>Grip</b>	Velo VLG-776
<b>Front light</b>	-
<b>Rear light</b>	-
<b>Seat post</b>	Promax 27.2 / 350 mm
<b>Max load</b>	125 kg
<b>Weight</b>	25.8 kg

<b>Type of motor</b>	Rear hub motor
<b>Brand of motor</b>	Bafang
<b>Model of motor</b>	SWX02
<b>Nominal power of motor</b>	250 W

<b>Torque</b>	45 N.m
<b>Voltage</b>	36 V

<b>Type of battery</b>	Li-ion
<b>Battery power</b>	522 – 630 Wh
<b>Voltage</b>	36 V
<b>Range</b>	up 140 km
<b>Cells brand</b>	LG / Greenway

<b>Display</b>	Monochromatic LCD
<b>Display brand</b>	Ecobike
<b>Display model</b>	C300U

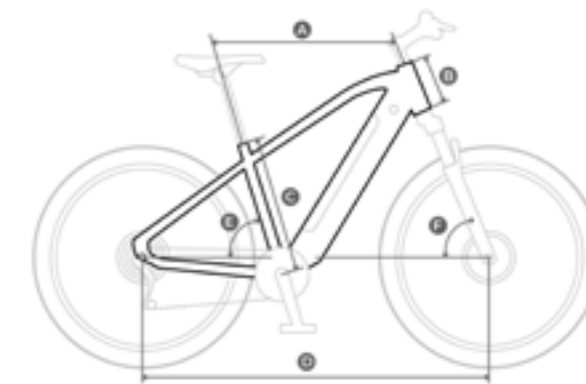







A  
B  
C  
D  
E  
F



ECOBIKE MTB  
**SX 300 Cool Gray**



Discover more

-  **24.6 kg**  
Weight
-  **250 W**  
Motor power
-  **556.8 - 672 Wh**  
Battery capacity
-  **135 km**  
Maximum range
-  **29"**  
Wheel
-  **20"**  
Frame

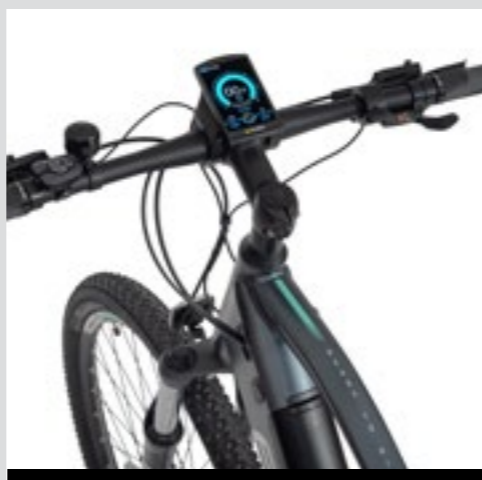

Specification

<b>Frame</b>	20" hydroformed aluminium
<b>Fork</b>	RST Blaze TNL 29" travel 100 mm
<b>Wheel</b>	29" reinforced three-chambered rims / Sapim spokes
<b>Tires</b>	29" x 2.20 Continental Race King
<b>Derailleur front</b>	-
<b>Derailleur rear</b>	Shimano Alivio 9-speed
<b>Shifter</b>	Shimano Altus 9-speed
<b>Brakes</b>	Shimano MT200 hydraulic
<b>Saddle</b>	Velo VL-3363
<b>Handlebar</b>	Zoom 720 mm 31.8
<b>Handlebar stem</b>	Zoom 7° / 70 mm
<b>Freewheel / Cassette</b>	Shimano HG-200 11-36T 9-speed
<b>Chain</b>	KMC X9
<b>Crank</b>	Ananda 42T
<b>Front hub</b>	Shimano TX505
<b>Rear hub</b>	Shimano TX505
<b>Bottom bracket</b>	-
<b>Pedals</b>	Velo
<b>Grip</b>	Velo VLG-776
<b>Front light</b>	-
<b>Rear light</b>	-
<b>Seat post</b>	Promax 27.2 / 350 mm
<b>Max load</b>	125 kg
<b>Weight</b>	24.6 kg

<b>Type of motor</b>	Middrive
<b>Brand of motor</b>	Ananda
<b>Model of motor</b>	M81
<b>Nominal power of motor</b>	250 W

<b>Torque</b>	100 N.m
<b>Voltage</b>	48 V

<b>Type of battery</b>	Li-ion
<b>Battery power</b>	556.8 - 672 Wh
<b>Voltage</b>	48 V
<b>Range</b>	up to 135 km
<b>Cells brand</b>	LG / Greenway

<b>Display</b>	Color LCD
<b>Display brand</b>	Ecobike
<b>Display model</b>	C900

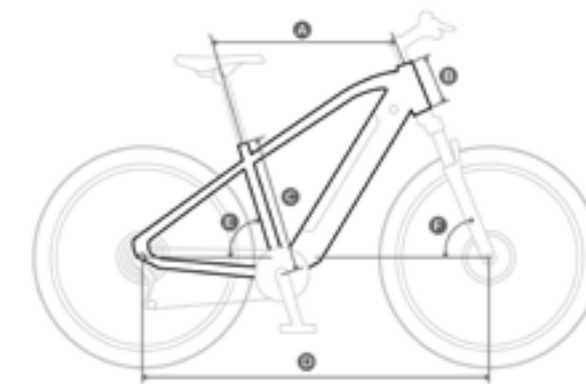

- A** 600 mm
- B** 165 mm
- C** 508 mm
- D** 1149.4 mm
- E** 73°
- F** 68°



E-bike system

ECOBIKE MTB

# SX 300 Sandstorm



Discover more

- 24.2 kg**  
Weight
- 250 W**  
Motor power
- 556.8 - 672 Wh**  
Battery capacity
- 135 km**  
Maximum range
- 29"**  
Wheel
- 18"**  
Frame

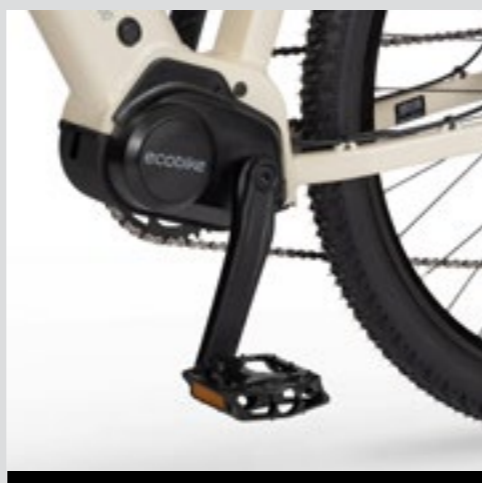

Specification

<b>Frame</b>	18" hydroformed aluminium
<b>Fork</b>	RST Blaze TNL 29" travel 100 mm
<b>Wheel</b>	29" reinforced three-chambered rims / Sapim spokes
<b>Tires</b>	29" x 2.20 Continental Race King
<b>Derailleur front</b>	-
<b>Derailleur rear</b>	Shimano Alivio 9-speed
<b>Shifter</b>	Shimano Altus 9-speed
<b>Brakes</b>	Shimano MT200 hydraulic
<b>Saddle</b>	Velo VL-3363
<b>Handlebar</b>	Zoom 720 mm 31.8
<b>Handlebar stem</b>	Zoom 7° / 70 mm
<b>Freewheel / Cassette</b>	Shimano HG-200 11-36T 9-speed
<b>Chain</b>	KMC X9
<b>Crank</b>	Ananda 42T
<b>Front hub</b>	Shimano TX505
<b>Rear hub</b>	Shimano TX505
<b>Bottom bracket</b>	-
<b>Pedals</b>	Velo
<b>Grip</b>	Velo VLG-776
<b>Front light</b>	-
<b>Rear light</b>	-
<b>Seat post</b>	Promax 27.2 / 350 mm
<b>Max load</b>	125 kg
<b>Weight</b>	24.2 kg

<b>Type of motor</b>	Middrive
<b>Brand of motor</b>	Ananda
<b>Model of motor</b>	M81
<b>Nominal power of motor</b>	250 W

<b>Torque</b>	100 N.m
<b>Voltage</b>	48 V
<b>Type of battery</b>	Li-ion
<b>Battery power</b>	556.8 - 672 Wh
<b>Voltage</b>	48 V
<b>Range</b>	up to 135 km
<b>Cells brand</b>	LG / Greenway

<b>Display</b>	Color LCD
<b>Display brand</b>	Ecobike
<b>Display model</b>	C900

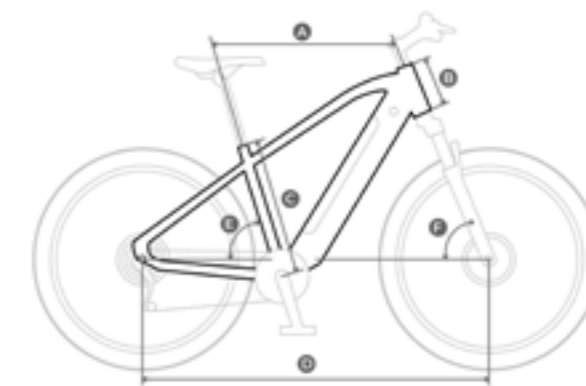



- A** 595.4 mm
- B** 165 mm
- C** 457 mm
- D** 1149.4 mm
- E** 73°
- F** 68°



E-bike system

# ECOBIKE MTB RX 500

 **26.3 kg / 26.5 kg**  
Weight

 **250 W**  
Motor power

 **840 Wh**  
Battery capacity

 **150 km**  
Maximum range

 **29"**  
Wheel

 **19" / 21"**  
Frame



Discover more

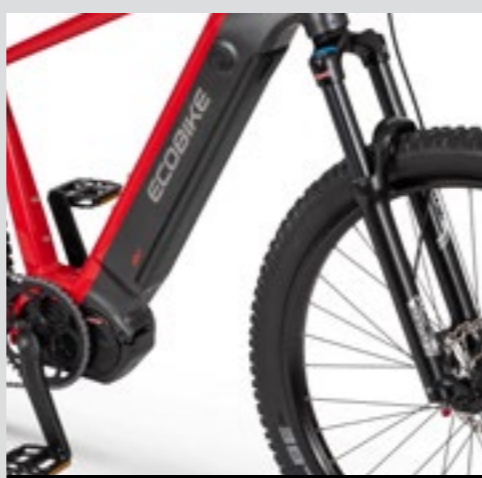
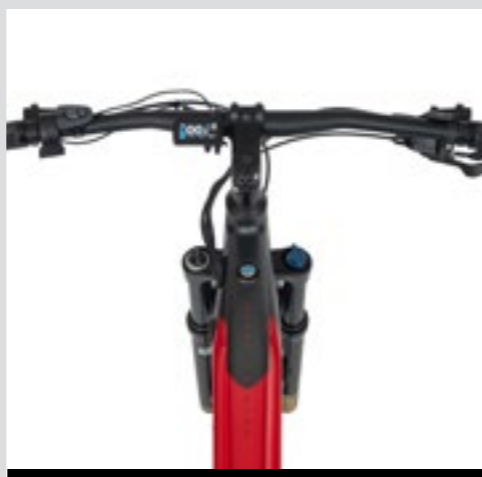
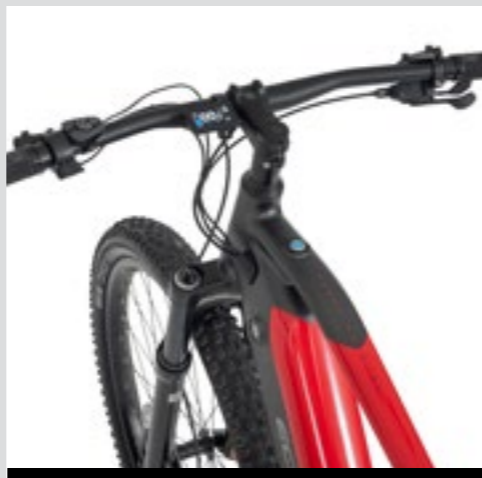

## Specification

<b>Frame</b>	19" / 21" hydroformed aluminium
<b>Fork</b>	SunTour XCR-AIR LOR skok 120 mm / RST Aerial skok 130 mm
<b>Wheel</b>	29" reinforced three-chambered rims / Sapim spokes
<b>Tires</b>	29" x 2.6 Schwalbe Nobby Nic
<b>Derailleur front</b>	-
<b>Derailleur rear</b>	Shimano Deore 10-speed
<b>Shifter</b>	Shimano Deore 10-speed
<b>Brakes</b>	Shimano MT400 hydraulic
<b>Saddle</b>	Velo VL-3363
<b>Handlebar</b>	Zoom 760 mm 31.8
<b>Handlebar stem</b>	Promax 7° / 70 mm
<b>Freewheel / Cassette</b>	Shimano CS-M4100 11-42T 10-speed
<b>Chain</b>	KMC E10
<b>Crank</b>	Ananda 44T
<b>Front hub</b>	Shimano TX505
<b>Rear hub</b>	Shimano TX505
<b>Bottom bracket</b>	-
<b>Pedals</b>	Velo
<b>Grip</b>	Herrmans RIB single lock
<b>Front light</b>	-
<b>Rear light</b>	-
<b>Seat post</b>	Zoom 27.2 / 350 mm
<b>Max load</b>	125 kg
<b>Weight</b>	26.3 kg (19") / 26.5 kg (21")

<b>Type of motor</b>	Middrive
<b>Brand of motor</b>	Ananda
<b>Model of motor</b>	M100
<b>Nominal power of motor</b>	250 W

<b>Torque</b>	130 N.m
<b>Voltage</b>	48 V

<b>Type of battery</b>	Li-ion
<b>Battery power</b>	840 Wh
<b>Voltage</b>	48 V
<b>Range</b>	up to 150 km
<b>Cells brand</b>	LG / Greenway

<b>Display</b>	Color LCD
<b>Display brand</b>	Ecobike
<b>Display model</b>	KD-586

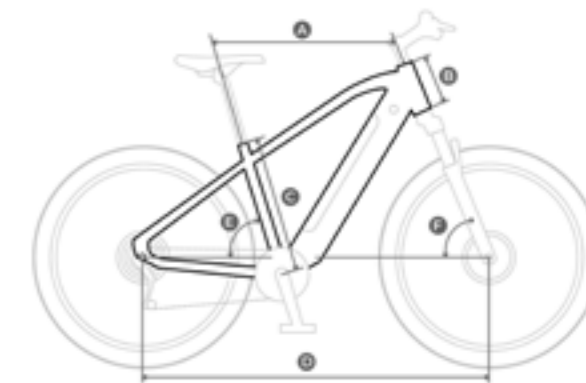

	19"	21"
<b>A</b>	625 mm	645 mm
<b>B</b>	145 mm	145 mm
<b>C</b>	482 mm	533 mm
<b>D</b>	1204.6 mm	1204.6 mm
<b>E</b>	73°	73°
<b>F</b>	67°	67°





## E-bike system

# Mauler NEW



Discover more

 **26.1 kg (M-L) / 26.4 kg (L-XL)**  
Weight

 **250 W**  
Motor power

 **720 - 1080 Wh**  
Battery capacity

 **200 km**  
Maximum range

 **29"**  
Wheel

 **M-L / L-XL**  
Frame

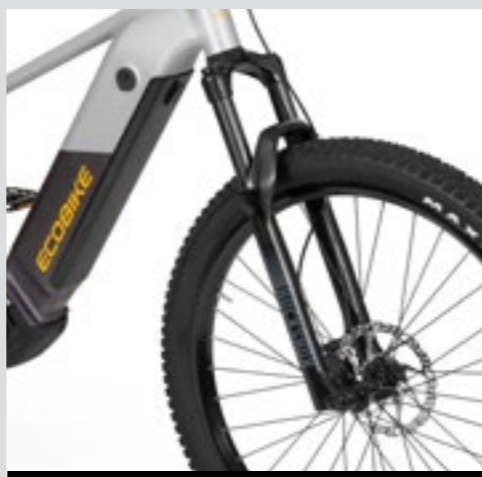

## Specification

<b>Frame</b>	M-L / L-XL hydroformed aluminum
<b>Fork</b>	Rockshox Recon travel 140 mm, through axle 15 x 110 mm
<b>Wheel</b>	29" reinforced three-chambered rims / Sapim spokes
<b>Tires</b>	29" x 2.6 Maxxis Rekon
<b>Derailleur front</b>	-
<b>Derailleur rear</b>	Shimano Deore 10 speed
<b>Shifter</b>	Shimano Deore 10 speed
<b>Brakes</b>	Shimano Deore MT401
<b>Saddle</b>	Velo VL-3363
<b>Handlebar</b>	Zoom 760 mm 35
<b>Handlebar stem</b>	Zoom 35 / 50 mm
<b>Freewheel / Cassette</b>	Shimano CS-M4100 Deore 11-42T 10 speed
<b>Chain</b>	KMC e10 Turbo Silver
<b>Crank</b>	Prowheel 175 mm
<b>Front hub</b>	Shimano HB-TC500-15-B 15 x 110 mm Center Lock, through axle
<b>Rear hub</b>	Shimano FH-TX505-8 36H Center Lock
<b>Bottom bracket</b>	-
<b>Pedals</b>	VP FP-203ZP
<b>Grip</b>	Herrmans Rib single lock
<b>Front light</b>	-
<b>Rear light</b>	-
<b>Seat post</b>	Zoom 30.9 x 440 mm, travel 125 mm
<b>Max load</b>	125 kg
<b>Weight</b>	26.1 kg (M-L) / 26.4 kg (L-XL)

<b>Type of motor</b>	Middrive
<b>Brand of motor</b>	Panasonic
<b>Model of motor</b>	GX Ultimate
<b>Nominal power of motor</b>	250 W

<b>Torque</b>	95 N.m
<b>Voltage</b>	36 V

<b>Type of battery</b>	Li-ion
<b>Battery power</b>	720 - 1080 Wh
<b>Voltage</b>	36 V
<b>Range</b>	up to 200 km
<b>Cells brand</b>	LG

<b>Display</b>	LCD monochromatic
<b>Display brand</b>	Panasonic
<b>Display model</b>	Side color display

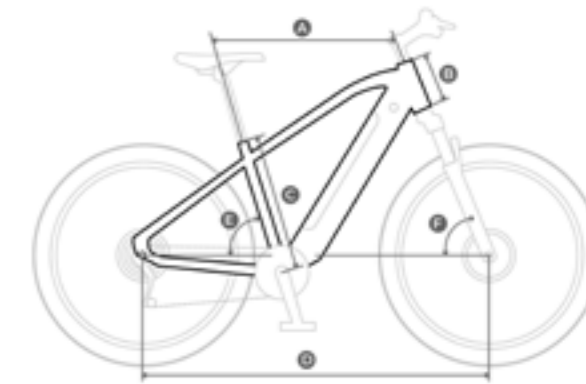

	M-L	L-XL
<b>A</b>	635 mm	650 mm
<b>B</b>	140	140
<b>C</b>	395.4 mm	463 mm
<b>D</b>	1260.9 mm	1275.9
<b>E</b>	71.7°	71.7°
<b>F</b>	64.9°	64.9°



# SUV

Two worlds closed in one e-bike - major comfort and all-terrain potential. Be sure that no conditions will change your mind. Combine your plans, your new SUV e-bike is all for it!



#READY  
FOR  
EXPERIENCE



ECOBIKE MTB

# Expedition Yellow

NEW



Discover more

**27.1 kg (17") / 27.4 kg (19") / 27.7 kg (21")**  
Weight

**250 W**  
Motor power

**720 - 1080 Wh**  
Battery capacity

**200 km**  
Maximum range

**29"**  
Wheel

**17" / 19" / 21"**  
Frame

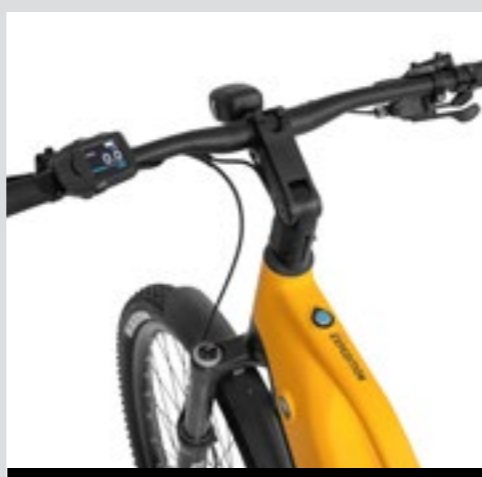
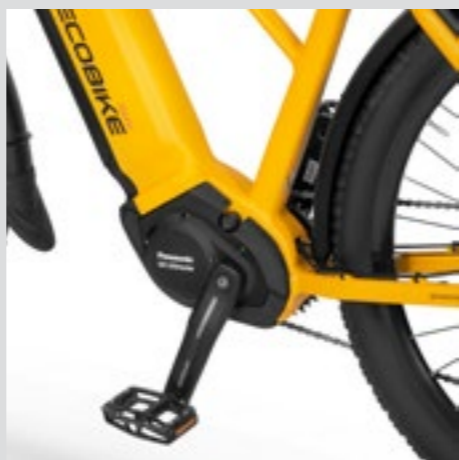
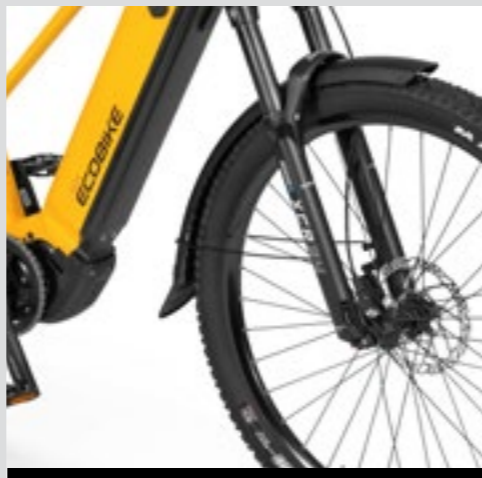

Specification

<b>Frame</b>	17" / 19" / 21" hydroformed aluminum
<b>Fork</b>	Suntour XCR 34 travel 120 mm
<b>Wheel</b>	29" reinforced three-chambered rims / Sapim spokes
<b>Tires</b>	29" x 2.4 Maxxis Rekon Race
<b>Derailleur front</b>	-
<b>Derailleur rear</b>	Shimano Deore 10 speed
<b>Shifter</b>	Shimano Deore 10 speed
<b>Brakes</b>	Shimano Deore MT401
<b>Saddle</b>	Velo VL-3625
<b>Handlebar</b>	Uno 720 mm 31.8
<b>Handlebar stem</b>	Zoom 31.8 / 90 mm
<b>Freewheel / Cassette</b>	Shimano CS-M4100 Deore 11-42T 10 speed
<b>Chain</b>	KMC e10 Turbo Silver
<b>Crank</b>	Prowheel 175 mm
<b>Front hub</b>	Shimano HB-TC500-15-B 15 x 110 mm Center Lock
<b>Rear hub</b>	Shimano FH-TX505-8 36H Center Lock
<b>Bottom bracket</b>	-
<b>Pedals</b>	VP FP-203ZP
<b>Grip</b>	Velo VLG-2052D2
<b>Front light</b>	Herrmans MR5
<b>Rear light</b>	Spaninga GLOW XE
<b>Seat post</b>	Promax SP-886 30.9 x 400 mm
<b>Max load</b>	125 kg
<b>Weight</b>	27.1 kg (17") / 27.4 kg (19") / 27.7 kg (21")

<b>Type of motor</b>	Midrive
<b>Brand of motor</b>	Panasonic
<b>Model of motor</b>	GX Ultimate
<b>Nominal power of motor</b>	250 W

<b>Torque</b>	95 N.m
<b>Voltage</b>	36 V

<b>Type of battery</b>	Li-ion
<b>Battery power</b>	720 - 1080 Wh
<b>Voltage</b>	36 V
<b>Range</b>	up to 200 km
<b>Cells brand</b>	LG

<b>Display</b>	LCD monochromatic
<b>Display brand</b>	Panasonic
<b>Display model</b>	Side color display

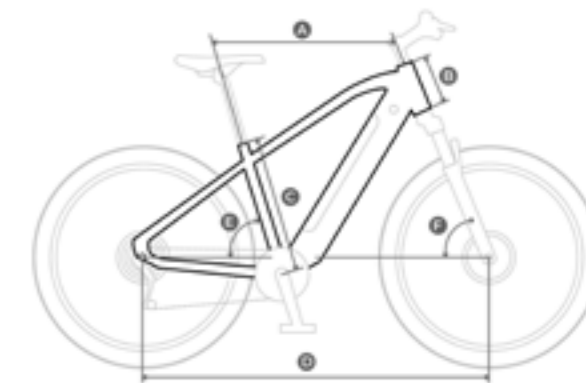

	17"	19"	21"
<b>A</b>	595 mm	610 mm	620 mm
<b>B</b>	145	145	145
<b>C</b>	433.5 mm	483.3 mm	533.2 mm
<b>D</b>	1156.7 mm	1171 mm	1181.7 mm
<b>E</b>	72.5°	72.5°	72.5°
<b>F</b>	68°	68°	68°



ECOBIKE MTB

# Expedition Midnight Black

NEW



Discover more

**27.1 kg (17") / 27.4 kg (19") / 27.7 kg (21")**

Weight

**250 W**

Motor power

**720 - 1080 Wh**

Battery capacity

**200 km**

Maximum range

**29"**

Wheel

**17" / 19" / 21"**

Frame

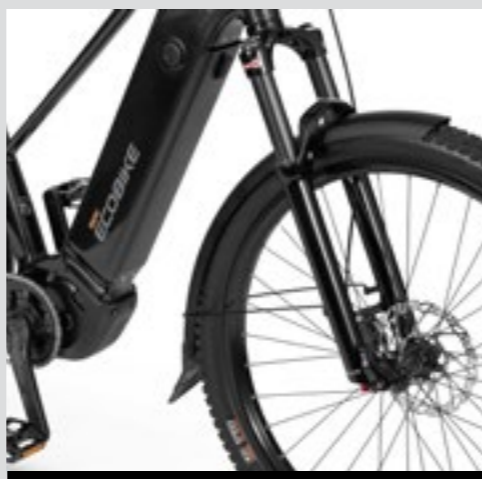
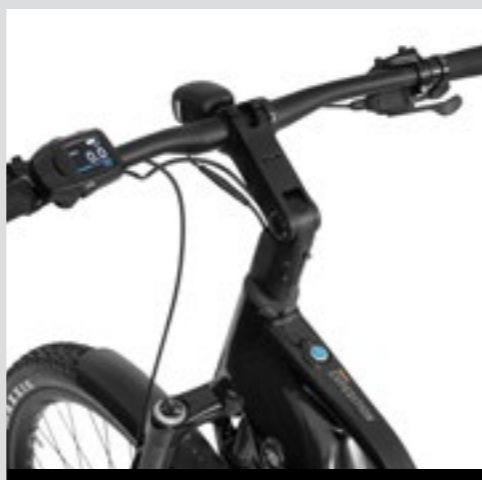
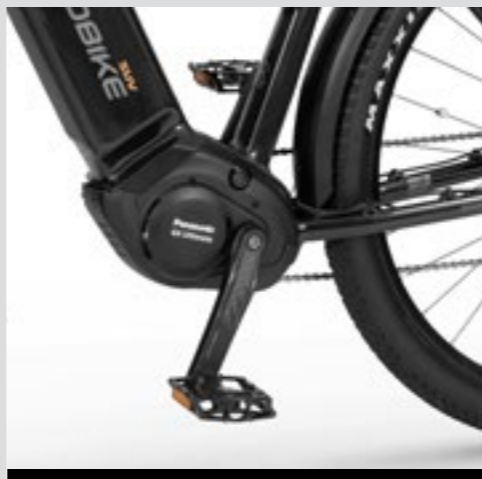

Specification

<b>Frame</b>	17" / 19" / 21" hydroformed aluminum
<b>Fork</b>	Suntour XCR 34 travel 120 mm
<b>Wheel</b>	29" reinforced three-chambered rims / Sapim spokes
<b>Tires</b>	29" x 2.4 Maxxis Rekon Race
<b>Derailleur front</b>	-
<b>Derailleur rear</b>	Shimano Deore 10 speed
<b>Shifter</b>	Shimano Deore 10 speed
<b>Brakes</b>	Shimano Deore MT401
<b>Saddle</b>	Velo VL-3625
<b>Handlebar</b>	Uno 720 mm 31.8
<b>Handlebar stem</b>	Zoom 31.8 / 90 mm
<b>Freewheel / Cassette</b>	Shimano CS-M4100 Deore 11-42T 10 speed
<b>Chain</b>	KMC e10 Turbo Silver
<b>Crank</b>	Prowheel 175 mm
<b>Front hub</b>	Shimano HB-TC500-15-B 15 x 110 mm Center Lock
<b>Rear hub</b>	Shimano FH-TX505-8 36H Center Lock
<b>Bottom bracket</b>	-
<b>Pedals</b>	VP FP-203ZP
<b>Grip</b>	Velo VLG-2052D2
<b>Front light</b>	Herrmans MR5
<b>Rear light</b>	Spaninga GLOW XE
<b>Seat post</b>	Promax SP-886 30.9 x 400 mm
<b>Max load</b>	125 kg
<b>Weight</b>	27.1 kg (17") / 27.4 kg (19") / 27.7 kg (21")

<b>Type of motor</b>	Middrive
<b>Brand of motor</b>	Panasonic
<b>Model of motor</b>	GX Ultimate
<b>Nominal power of motor</b>	250 W

<b>Torque</b>	95 N.m
<b>Voltage</b>	36 V

<b>Type of battery</b>	Li-ion
<b>Battery power</b>	720 - 1080 Wh
<b>Voltage</b>	36 V
<b>Range</b>	up to 200 km
<b>Cells brand</b>	LG

<b>Display</b>	LCD monochromatic
<b>Display brand</b>	Panasonic
<b>Display model</b>	Side color display

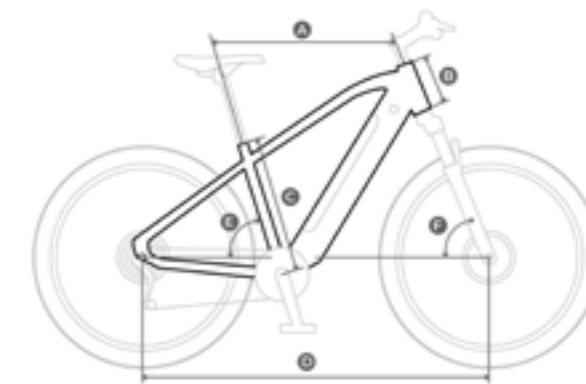

	17"	19"	21"
<b>A</b>	595 mm	610 mm	620 mm
<b>B</b>	145	145	145
<b>C</b>	433.5 mm	483.3 mm	533.2 mm
<b>D</b>	1156.7 mm	1171 mm	1181.7 mm
<b>E</b>	72.5°	72.5°	72.5°
<b>F</b>	68°	68°	68°







**#READY  
TO  
TRAVEL**



---

# TREKKING







Our most universal e-bike models.  
Choose an electric bike that will work both  
in the urban space and outside of it.  
Travel anywhere without limits!

ECOBIKE TREKKING

# Forest



Discover more

-  **16.8 kg**  
Weight
-  **250 W**  
Motor power
-  **349.2 Wh**  
Battery capacity
-  **80 km**  
Maximum range
-  **28"**  
Wheel
-  **19"**  
Frame

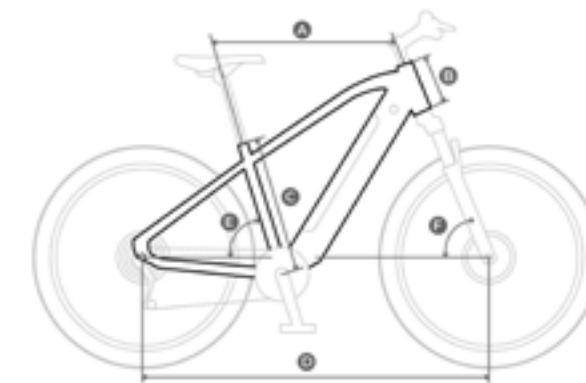
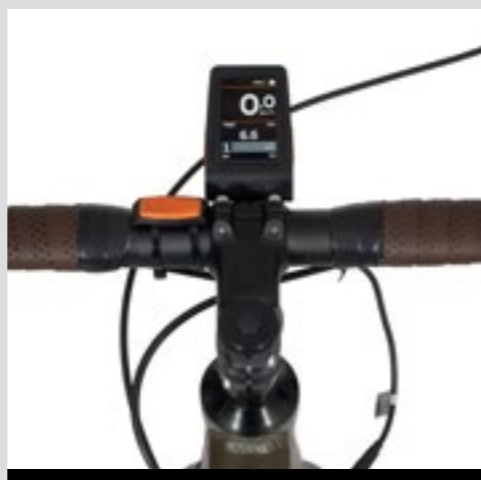

- A 590 mm
- B 120 mm
- C 490 mm
- D 1087.5 mm
- E 74°
- F 70.5°

Specification

<b>Frame</b>	19" hydroformed aluminium
<b>Fork</b>	aluminium
<b>Wheel</b>	28" reinforced three-chambered rims / Sapim spokes
<b>Tires</b>	28" x 1.6 CST Tirent
<b>Derailleur front</b>	-
<b>Derailleur rear</b>	Microshift Advent X RD-M6205GM 10-speed
<b>Shifter</b>	Microshift Advent X SB-M100A 10-speed
<b>Brakes</b>	Tektro MD M300 mechanical
<b>Saddle</b>	Velo VL-3381
<b>Handlebar</b>	Promax 440 mm 31.8
<b>Handlebar stem</b>	Zoom 7° / 70 mm
<b>Freewheel / Cassette</b>	Microshift Advent X CS-H104 11-48T 10-speed
<b>Chain</b>	KMC e10
<b>Crank</b>	Prowheel 44T
<b>Front hub</b>	KT-XA2F
<b>Rear hub</b>	Motor
<b>Bottom bracket</b>	Bafang
<b>Pedals</b>	VP
<b>Grip</b>	Velo handle tap
<b>Front light</b>	-
<b>Rear light</b>	-
<b>Seat post</b>	Zoom 27.2 / 300 mm
<b>Max load</b>	125 kg
<b>Weight</b>	16.8 kg

<b>Type of motor</b>	Rear hub motor
<b>Brand of motor</b>	Bafang
<b>Model of motor</b>	RM G370 250 DC
<b>Nominal power of motor</b>	250 W

<b>Torque</b>	30 N.m
<b>Voltage</b>	36 V

<b>Type of battery</b>	Li-ion
<b>Battery power</b>	349.2 Wh
<b>Voltage</b>	36 V
<b>Range</b>	up to 80 km
<b>Cells brand</b>	Greenway

<b>Display</b>	LCD
<b>Display brand</b>	Bafang
<b>Display model</b>	C260 CAN

E-bike system









ECOBIKE TREKKING  
**D1 Trekking**



Discover more



-  **27.5 kg**  
Weight
-  **250 W**  
Motor power
-  **672 Wh**  
Battery capacity
-  **130 km**  
Maximum range
-  **28"**  
Wheel
-  **19"**  
Frame

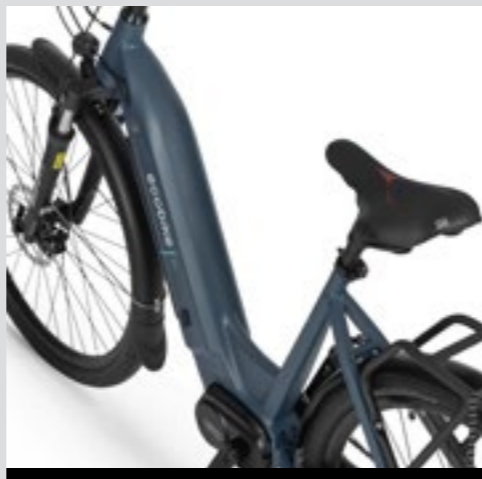

Specification

<b>Frame</b>	19" hydroformed aluminium
<b>Fork</b>	SunTour SF15 NEX-E25 travel 63 mm
<b>Wheel</b>	28" reinforced three-chambered rims / Sapim spokes
<b>Tires</b>	28" x 1.95 TRC INDIGO
<b>Derailleur front</b>	-
<b>Derailleur rear</b>	Shimano Deore 10-speed
<b>Shifter</b>	Shimano Deore 10-speed
<b>Brakes</b>	Alhonga HJ-HT472 hydraulic
<b>Saddle</b>	Selle Royal Lookin Basic
<b>Handlebar</b>	Promax 700 mm 31.8
<b>Handlebar stem</b>	Promax 0 - 40° / 90 mm
<b>Freewheel / Cassette</b>	Shimano CS-M4100 11-42T 10-speed
<b>Chain</b>	KMC
<b>Crank</b>	Bafang 44T
<b>Front hub</b>	KT-SN6F
<b>Rear hub</b>	KT-SN6R
<b>Bottom bracket</b>	Bafang
<b>Pedals</b>	VP
<b>Grip</b>	Velo VLG-1189AD3
<b>Front light</b>	Spaninga Kendo XE
<b>Rear light</b>	Spaninga MLL XE
<b>Seat post</b>	Promax 27.2 / 350 mm
<b>Max load</b>	125 kg
<b>Weight</b>	27.5 kg

<b>Type of motor</b>	Middrive
<b>Brand of motor</b>	Bafang
<b>Model of motor</b>	M420
<b>Nominal power of motor</b>	250 W

<b>Torque</b>	80 N.m
<b>Voltage</b>	48 V

<b>Type of battery</b>	Li-ion
<b>Battery power</b>	672 Wh
<b>Voltage</b>	48 V
<b>Range</b>	up to 130 km
<b>Cells brand</b>	LG

<b>Display</b>	Color LCD
<b>Display brand</b>	Bafang
<b>Display model</b>	C18

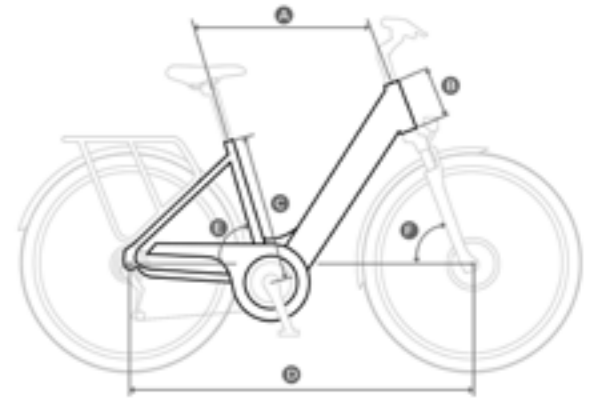

- A** 615 mm
- B** 150 mm
- C** 482 mm
- D** 1132.6 mm
- E** 73°
- F** 70°



E-bike system

ECOBIKE TREKKING

# X-Cross White

NEW



Discover more

**26.7 kg (17") / 26.9 kg (19")**  
Weight

**250 W**  
Motor power

**522 - 630 Wh**  
Battery capacity

**140 km**  
Maximum range

**28"**  
Wheel

**17" / 19"**  
Frame

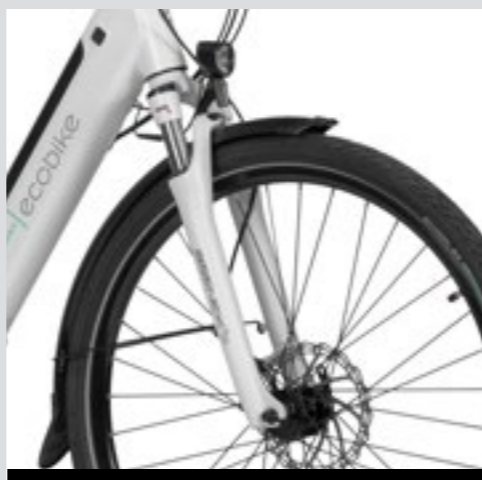

Specification

<b>Frame</b>	17" / 19" hydroformed aluminum
<b>Fork</b>	SunTour SF15 NEX-E25 travel 63 mm
<b>Wheel</b>	28" reinforced three-chambered rims / Sapim spokes
<b>Tires</b>	28" x 1.95 Schwalbe Energizer Plus
<b>Derailleur front</b>	-
<b>Derailleur rear</b>	Shimano Alivio 9 speed
<b>Shifter</b>	Shimano Altus 9 speed
<b>Brakes</b>	Alhonga HJ-HT472 hydraulic
<b>Saddle</b>	Selle Royal Lookin Basic
<b>Handlebar</b>	Promax 700 mm 31.8
<b>Handlebar stem</b>	Promax 0 - 40° / 90 mm
<b>Freewheel / Cassette</b>	Shimano HG-200 11-34T 9 speed
<b>Chain</b>	KMC X9
<b>Crank</b>	Topwheel 48T
<b>Front hub</b>	KT-K68F
<b>Rear hub</b>	Motor
<b>Bottom bracket</b>	Feimin FP-B902W
<b>Pedals</b>	VP
<b>Grip</b>	Velo VLG-776
<b>Front light</b>	Spaninga Kendo XE
<b>Rear light</b>	Spaninga GLOW XE
<b>Seat post</b>	Uno 27.2 / 350 mm
<b>Max load</b>	125 kg
<b>Weight</b>	26.7 kg (17") / 26.9 kg (19")

<b>Type of motor</b>	Rear hub motor
<b>Brand of motor</b>	Bafang
<b>Model of motor</b>	SWX02
<b>Nominal power of motor</b>	250 W

<b>Torque</b>	45 N.m
<b>Voltage</b>	36 V

<b>Type of battery</b>	Li-ion
<b>Battery power</b>	522 - 630 Wh
<b>Voltage</b>	36 V
<b>Range</b>	up to 140 km
<b>Cells brand</b>	LG

<b>Display</b>	color LCD
<b>Display brand</b>	Bafang
<b>Display model</b>	C270



	17"	19"
<b>A</b>	590 mm	605 mm
<b>B</b>	160	160
<b>C</b>	432 mm	482 mm
<b>D</b>	1120 mm	1135.6 mm
<b>E</b>	73°	73°
<b>F</b>	69°	69°



E-bike system

ECOBIKE TREKKING

# X-Cross Black

NEW



Discover more

 **26.7 kg (17") / 26.9 kg (19")**

Weight

 **250 W**

Motor power

 **522 - 630 Wh**

Battery capacity

 **140 km**

Maximum range

 **28"**

Wheel

 **17" / 19"**

Frame



Specification

<b>Frame</b>	17" / 19" hydroformed aluminium
<b>Fork</b>	SunTour SF15 NEX-E25 travel 63 mm
<b>Wheel</b>	28" reinforced three-chambered rims / Sapim spokes
<b>Tires</b>	28" x 1.95 Schwalbe Energizer Plus
<b>Derailleur front</b>	-
<b>Derailleur rear</b>	Shimano Alivio 9 speed
<b>Shifter</b>	Shimano Altus 9 speed
<b>Brakes</b>	Alhonga HJ-HT472 hydraulic
<b>Saddle</b>	Selle Royal Lookin Basic
<b>Handlebar</b>	Promax 700 mm 31.8
<b>Handlebar stem</b>	Promax 0 - 40° / 90 mm
<b>Freewheel / Cassette</b>	Shimano HG-200 11-34T 9 speed
<b>Chain</b>	KMC X9
<b>Crank</b>	Topwheel 48T
<b>Front hub</b>	KT-K68F
<b>Rear hub</b>	Motor
<b>Bottom bracket</b>	Feimin FP-B902W
<b>Pedals</b>	VP
<b>Grip</b>	Velo VLG-776
<b>Front light</b>	Spaninga Kendo XE
<b>Rear light</b>	Spaninga GLOW XE
<b>Seat post</b>	Uno 27.2 / 350 mm
<b>Max load</b>	125 kg
<b>Weight</b>	26.7 kg (17") / 26.9 kg (19")

<b>Type of motor</b>	Rear hub motor
<b>Brand of motor</b>	Bafang
<b>Model of motor</b>	SWX02
<b>Nominal power of motor</b>	250 W

<b>Torque</b>	45 N.m
<b>Voltage</b>	36 V

<b>Type of battery</b>	Li-ion
<b>Battery power</b>	522 - 630 Wh
<b>Voltage</b>	36 V
<b>Range</b>	up to 140 km
<b>Cells brand</b>	LG

<b>Display</b>	color LCD
<b>Display brand</b>	Bafang
<b>Display model</b>	C270



	17"	19"
<b>A</b>	590 mm	605 mm
<b>B</b>	160	160
<b>C</b>	432 mm	482 mm
<b>D</b>	1120 mm	1135.6 mm
<b>E</b>	73°	73°
<b>F</b>	69°	69°



ECOBIKE TREKKING

# X-Cross M

NEW



Discover more

 **27.3 kg (19") / 27.6 (21")**

Weight

 **250 W**

Motor power

 **522 - 630 Wh**

Battery capacity

 **140 km**

Maximum range

 **28"**

Wheel

 **19" / 21"**

Frame

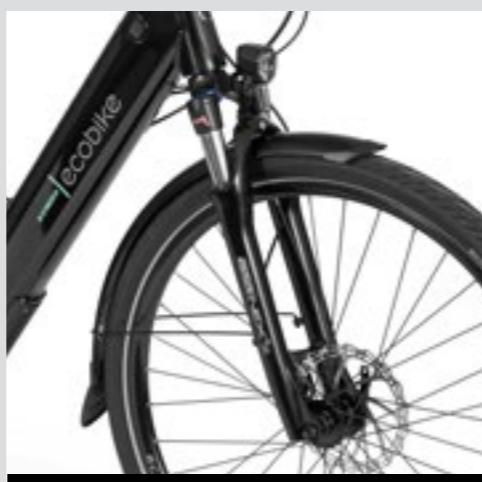
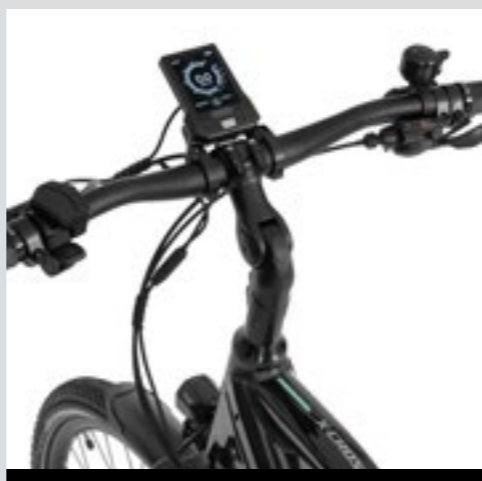
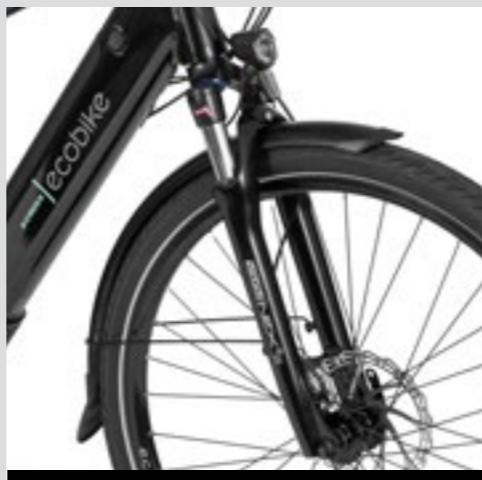

Specification

<b>Frame</b>	19" / 21" hydroformowane aluminium
<b>Fork</b>	SunTour SF15 NEX-E25 travel 63 mm
<b>Wheel</b>	28" reinforced three-chambered rims / Sapim spokes
<b>Tires</b>	28" x 1.95 Schwalbe Energizer Plus
<b>Derailleur front</b>	-
<b>Derailleur rear</b>	Shimano Alivio 9 speed
<b>Shifter</b>	Shimano Altus 9 speed
<b>Brakes</b>	Alhonga HJ-HT472 hydraulic
<b>Saddle</b>	Selle Royal Lookin Basic
<b>Handlebar</b>	Promax 700 mm 31.8
<b>Handlebar stem</b>	Promax 0 - 40° / 90 mm
<b>Freewheel / Cassette</b>	Shimano HG-200 11-34T 9 speed
<b>Chain</b>	KMC X9
<b>Crank</b>	Topwheel 48T
<b>Front hub</b>	KT-K68F
<b>Rear hub</b>	Motor
<b>Bottom bracket</b>	Feimin FP-B902W
<b>Pedals</b>	VP
<b>Grip</b>	Velo VLG-776
<b>Front light</b>	Spaninga Kendo XE
<b>Rear light</b>	Spaninga GLOW XE
<b>Seat post</b>	Uno 27.2 / 350 mm
<b>Max load</b>	125 kg
<b>Weight</b>	27.3 kg (19") / 27.6 (21")

<b>Type of motor</b>	Rear hub motor
<b>Brand of motor</b>	Bafang
<b>Model of motor</b>	SWX02
<b>Nominal power of motor</b>	250 W

<b>Torque</b>	45 N.m
<b>Voltage</b>	36 V

<b>Type of battery</b>	Li-ion
<b>Battery power</b>	522 - 630 Wh
<b>Voltage</b>	36 V
<b>Range</b>	up to 140 km
<b>Cells brand</b>	LG

<b>Display</b>	color LCD
<b>Display brand</b>	Bafang
<b>Display model</b>	C270

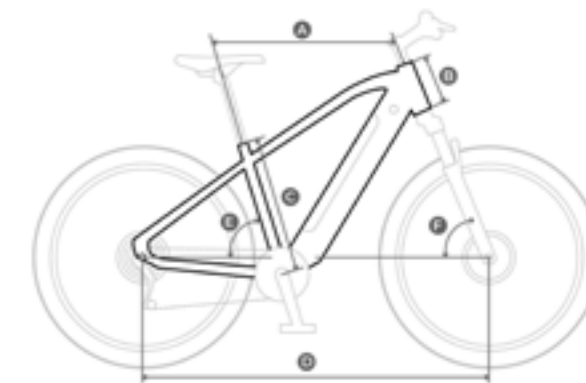







	19"	21"
<b>A</b>	605 mm	615 mm
<b>B</b>	160	160
<b>C</b>	482 mm	533 mm
<b>D</b>	1135,7 mm	1145 mm
<b>E</b>	73°	73°
<b>F</b>	69°	69°



# ECOBIKE TREKKING LX



Discover more

-  **25.9 kg**  
Weight
-  **250 W**  
Motor power
-  **556.8 - 672 Wh**  
Battery capacity
-  **135 km**  
Maximum range
-  **28"**  
Wheel
-  **19" / 21"**  
Frame

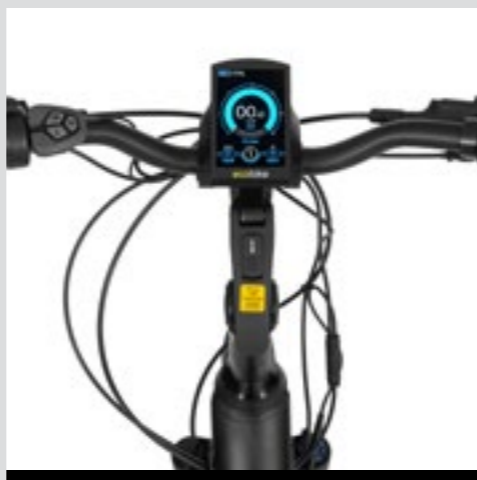
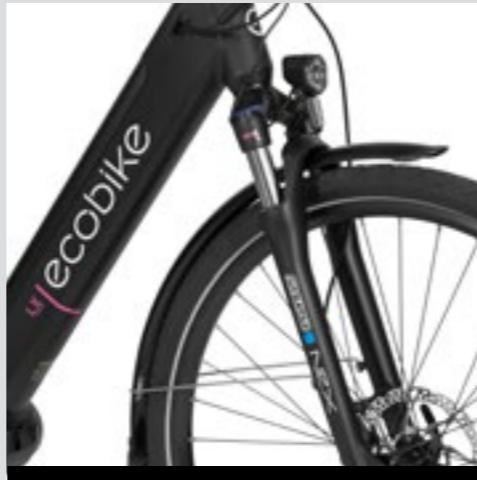

## Specification

<b>Frame</b>	19" / 21" hydroformed aluminium
<b>Fork</b>	SunTour NEX HLO-DS travel 63 mm
<b>Wheel</b>	28" reinforced three-chambered rims / Sapim spokes
<b>Tires</b>	28" x 1.75 Schwalbe Energizer Plus
<b>Derailleur front</b>	-
<b>Derailleur rear</b>	Shimano NEXUS 7-speed
<b>Shifter</b>	Shimano NEXUS Revo 7-speed
<b>Brakes</b>	Shimano MT200 hydraulic
<b>Saddle</b>	Selle Royal Lookin Basic
<b>Handlebar</b>	Promax 660 mm 25.4
<b>Handlebar stem</b>	Promax 7° / 110 mm
<b>Freewheel / Cassette</b>	Shimano NEXUS 20T
<b>Chain</b>	KMC
<b>Crank</b>	Prowheel 44T
<b>Front hub</b>	Shimano TX505
<b>Rear hub</b>	Shimano NEXUS
<b>Bottom bracket</b>	-
<b>Pedals</b>	Velo
<b>Grip</b>	Velo VLG-519AD2
<b>Front light</b>	Spaninga Kendo XE
<b>Rear light</b>	Spaninga MLL XE
<b>Seat post</b>	Promax 27.2 / 350 mm
<b>Max load</b>	125 kg
<b>Weight</b>	25.9 kg

<b>Type of motor</b>	Middrive
<b>Brand of motor</b>	Ananda
<b>Model of motor</b>	M81
<b>Nominal power of motor</b>	250 W

<b>Torque</b>	100 N.m
<b>Voltage</b>	48 V

<b>Type of battery</b>	Li-ion
<b>Battery power</b>	556.8 - 672 Wh
<b>Voltage</b>	48 V
<b>Range</b>	up to 135 km
<b>Cells brand</b>	LG / Greenway

<b>Display</b>	Color LCD
<b>Display brand</b>	Ecobike
<b>Display model</b>	C900



	19"	21"
<b>A</b>	595 mm	605.7 mm
<b>B</b>	162 mm	162 mm
<b>C</b>	482 mm	533 mm
<b>D</b>	1121.8 mm	1132.5 mm
<b>E</b>	73°	73°
<b>F</b>	70°	70°



## E-bike system

# ECOBIKE TREKKING MX



**27 kg**  
Weight



**250 W**  
Motor power



**556.8 - 672 Wh**  
Battery capacity



**135 km**  
Maximum range



**28"**  
Wheel



**20" / 23"**  
Frame



Discover more

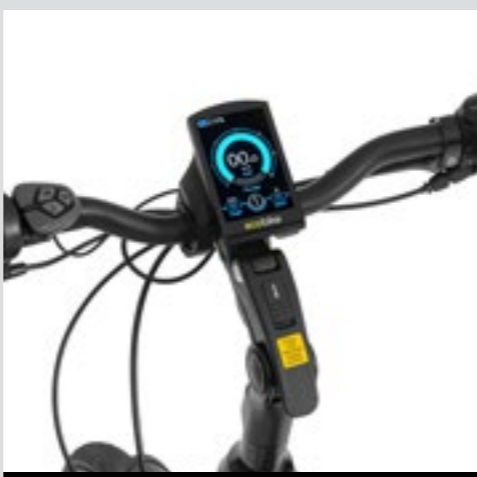
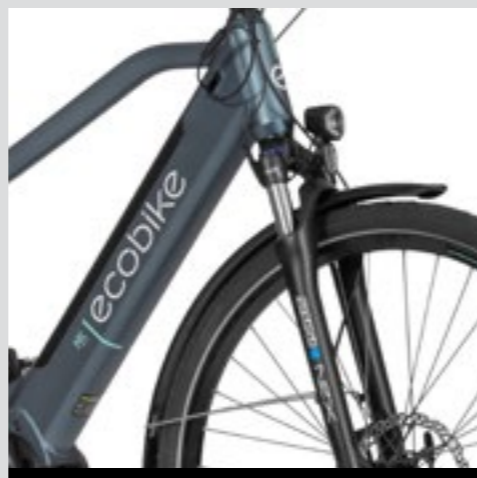

## Specification

<b>Frame</b>	20" / 23" hydroformed aluminium
<b>Fork</b>	SunTour NEX HLO-DS travel 63 mm
<b>Wheel</b>	28" reinforced three-chambered rims / Sapim spokes
<b>Tires</b>	28" x 1.75 Schwalbe Energizer Plus
<b>Derailleur front</b>	-
<b>Derailleur rear</b>	Shimano NEXUS 7-speed
<b>Shifter</b>	Shimano NEXUS Revo 7-speed
<b>Brakes</b>	Shimano MT200 hydraulic
<b>Saddle</b>	Selle Royal Lookin Basic
<b>Handlebar</b>	Promax 660 mm 25.4
<b>Handlebar stem</b>	Promax 7° / 110 mm
<b>Freewheel / Cassette</b>	Shimano NEXUS 20T
<b>Chain</b>	KMC
<b>Crank</b>	Prowheel 44T
<b>Front hub</b>	Shimano TX505
<b>Rear hub</b>	Shimano NEXUS
<b>Bottom bracket</b>	-
<b>Pedals</b>	Velo
<b>Grip</b>	Velo VLG-519AD2
<b>Front light</b>	Spaninga Kendo XE
<b>Rear light</b>	Spaninga MLL XE
<b>Seat post</b>	Promax 27.2 / 350 mm
<b>Max load</b>	125 kg
<b>Weight</b>	27 kg

<b>Type of motor</b>	Middrive
<b>Brand of motor</b>	Ananda
<b>Model of motor</b>	M81
<b>Nominal power of motor</b>	250 W

<b>Torque</b>	100 N.m
<b>Voltage</b>	48 V

<b>Type of battery</b>	Li-ion
<b>Battery power</b>	556.8 - 672 Wh
<b>Voltage</b>	48 V
<b>Range</b>	up to 135 km
<b>Cells brand</b>	LG / Greenway

<b>Display</b>	Color LCD
<b>Display brand</b>	Ecobike
<b>Display model</b>	C900

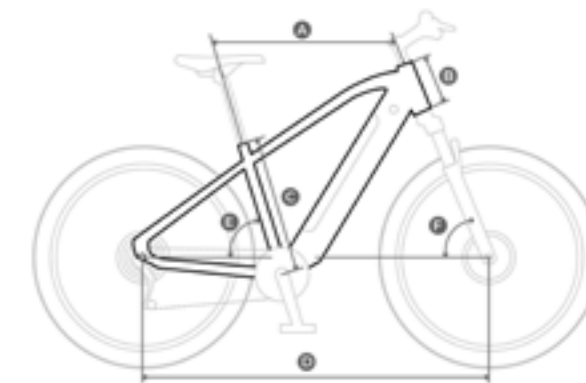

	20"	23"
<b>A</b>	610 mm	620.7 mm
<b>B</b>	162 mm	162 mm
<b>C</b>	508 mm	584 mm
<b>D</b>	1136.8 mm	1147.5 mm
<b>E</b>	73°	73°
<b>F</b>	70°	70°



## E-bike system



ECOBIKE TREKKING

# LX 300 White Rose



Discover more

- 25.9 kg**  
Weight
- 250 W**  
Motor power
- 556.8 - 672 Wh**  
Battery capacity
- 135 km**  
Maximum range
- 28"**  
Wheel
- 17"**  
Frame

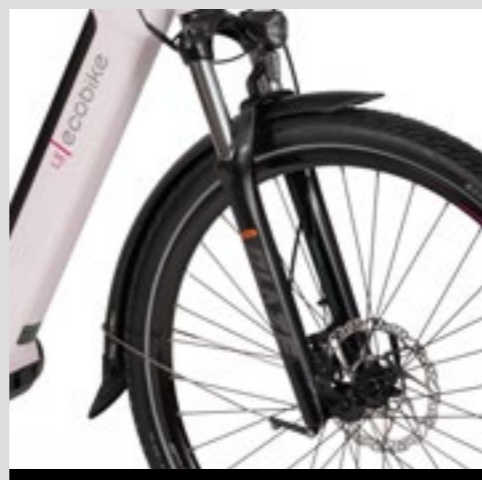
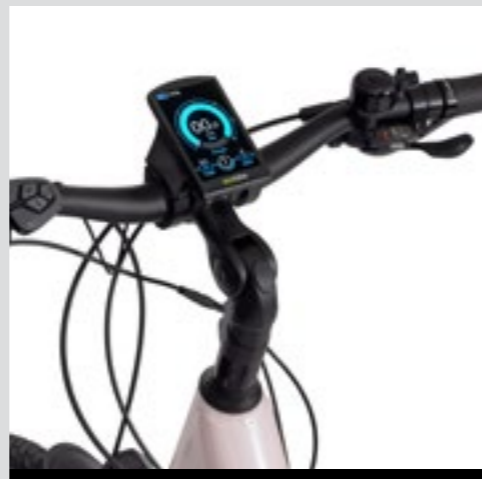

Specification

<b>Frame</b>	17" hydroformed aluminium
<b>Fork</b>	RST BLAZE TNL29" travel 100 mm
<b>Wheel</b>	28" reinforced three-chambered rims / Sapim spokes
<b>Tires</b>	28" x 2.20 Continental ContiCrusier
<b>Derailleur front</b>	-
<b>Derailleur rear</b>	Shimano Alivio 9-speed
<b>Shifter</b>	Shimano Altus 9-speed
<b>Brakes</b>	Shimano MT200 hydraulic
<b>Saddle</b>	Selle Royal Ariel
<b>Handlebar</b>	Promax 700 mm 31.8
<b>Handlebar stem</b>	Promax 0 - 40° / 90 mm
<b>Freewheel / Cassette</b>	Shimano HG-200 11-36T 9-speed
<b>Chain</b>	KMC E9
<b>Crank</b>	Ananda 44T
<b>Front hub</b>	NEXELO
<b>Rear hub</b>	NEXELO
<b>Bottom bracket</b>	-
<b>Pedals</b>	VP
<b>Grip</b>	Velo VLG-1189AD3
<b>Front light</b>	Spaninga Kendo XE
<b>Rear light</b>	Spaninga MLL XE
<b>Seat post</b>	Promax 27.2 / 350 mm
<b>Max load</b>	125 kg
<b>Weight</b>	25.9 kg

<b>Type of motor</b>	Midrive
<b>Brand of motor</b>	Ananda
<b>Model of motor</b>	M81
<b>Nominal power of motor</b>	250 W

<b>Torque</b>	100 N.m
<b>Voltage</b>	48 V
<b>Type of battery</b>	Li-ion
<b>Battery power</b>	556.8 - 672 Wh
<b>Voltage</b>	48 V
<b>Range</b>	up to 135 km
<b>Cells brand</b>	LG / Greenway

<b>Display</b>	Color LCD
<b>Display brand</b>	Ecobike
<b>Display model</b>	C900

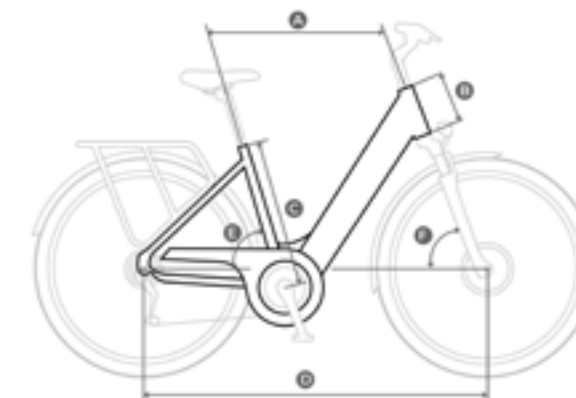







- A** 586.2 mm
- B** 170 mm
- C** 432 mm
- D** 1109.2 mm
- E** 73°
- F** 70°



ECOBIKE TREKKING  
**MX 300 Green**



Discover more

-  **26.3 kg**  
Weight
-  **250 W**  
Motor power
-  **556.8 - 672 Wh**  
Battery capacity
-  **135 km**  
Maximum range
-  **28"**  
Wheel
-  **19"**  
Frame

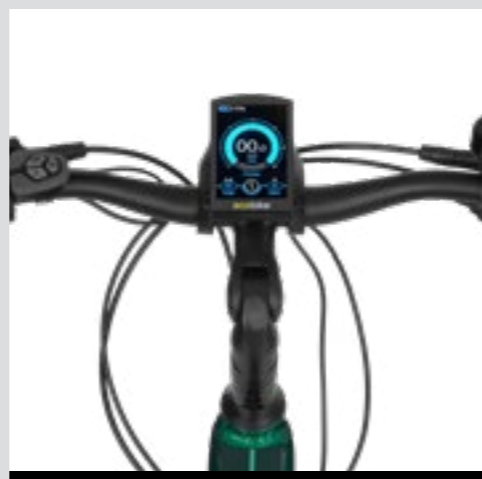
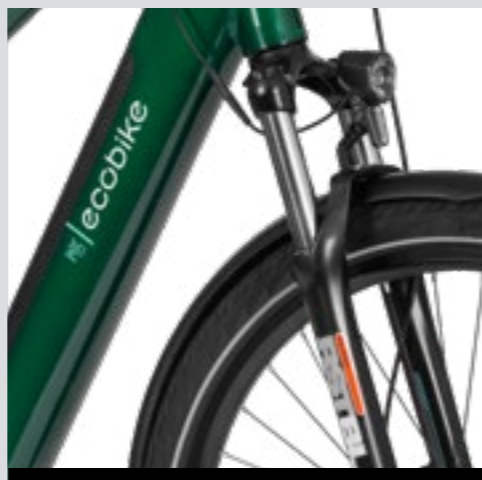
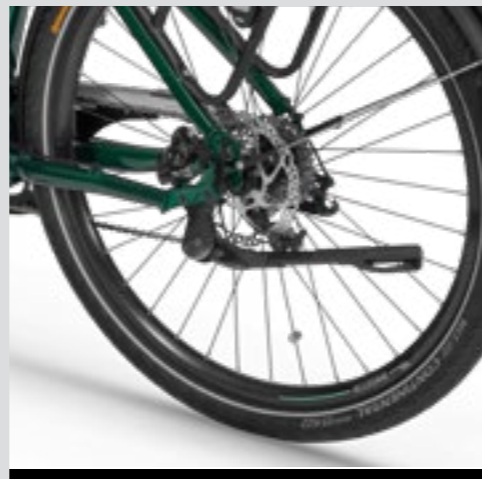

Specification

<b>Frame</b>	19" hydroformed aluminium
<b>Fork</b>	RST BLAZE TNL29" travel 100 mm
<b>Wheel</b>	28" reinforced three-chambered rims / Sapim spokes
<b>Tires</b>	28" x 2.20 Continental ContiCrusier
<b>Derailleur front</b>	-
<b>Derailleur rear</b>	SRAM GX, 10-speed
<b>Shifter</b>	SRAM GX Trigger
<b>Brakes</b>	Shimano MT200 hydraulic
<b>Saddle</b>	Selle Royal Ariel
<b>Handlebar</b>	Promax 700 mm 31.8
<b>Handlebar stem</b>	Promax 0 - 40° / 90 mm
<b>Freewheel / Cassette</b>	SRAM GX, 10-speed
<b>Chain</b>	KMC e10 Sports
<b>Crank</b>	Ananda 44T
<b>Front hub</b>	NEXELO
<b>Rear hub</b>	NEXELO
<b>Bottom bracket</b>	-
<b>Pedals</b>	VP
<b>Grip</b>	Velo VLG-1189AD3
<b>Front light</b>	Spaninga Kendo XE
<b>Rear light</b>	Spaninga MLL XE
<b>Seat post</b>	Promax 27.2 / 350 mm
<b>Max load</b>	125 kg
<b>Weight</b>	26.3 kg

<b>Type of motor</b>	Middrive
<b>Brand of motor</b>	Ananda
<b>Model of motor</b>	M81
<b>Nominal power of motor</b>	250 W

<b>Torque</b>	100 N.m
<b>Voltage</b>	48 V

<b>Type of battery</b>	Li-ion
<b>Battery power</b>	499,2 - 672 Wh
<b>Voltage</b>	48 V
<b>Range</b>	up to 135 km
<b>Cells brand</b>	LG / Greenway

<b>Display</b>	Color LCD
<b>Display brand</b>	Ecobike
<b>Display model</b>	C900

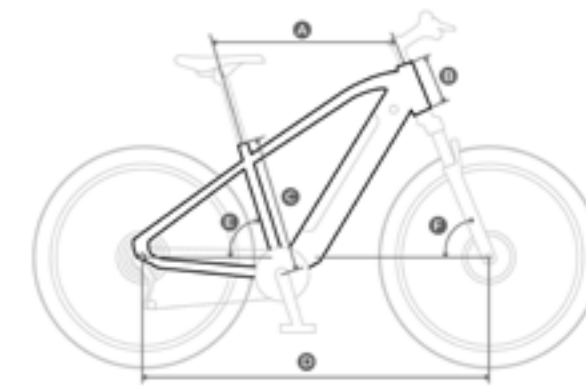

- A** 593.2 mm
- B** 170 mm
- C** 482 mm
- D** 1109.2 mm
- E** 72.4°
- F** 70°









E-bike system

ECOBIKE TREKKING  
**LX 500 Mint**



Discover more

-  **29 kg**  
Weight
-  **250 W**  
Motor power
-  **696 - 960 Wh**  
Battery capacity
-  **150 km**  
Maximum range
-  **28"**  
Wheel
-  **17"**  
Frame

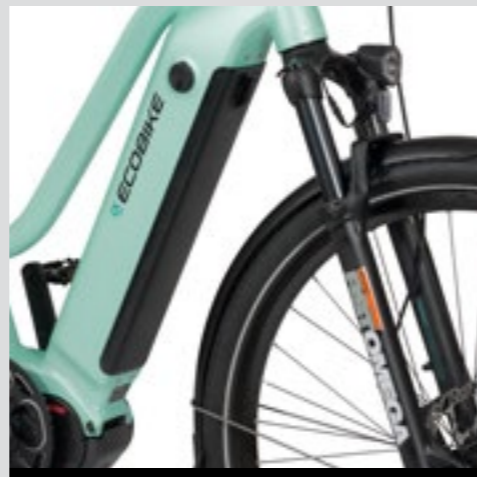

Specification

<b>Frame</b>	17" hydroformed aluminium
<b>Fork</b>	RST OMEGA-TNL-29" travel 100 mm
<b>Wheel</b>	28" reinforced three-chambered rims / Sapim spokes
<b>Tires</b>	28" x 2.15 Schwalbe Big Ben Plus
<b>Derailleur front</b>	-
<b>Derailleur rear</b>	Shimano Deore 10-speed
<b>Shifter</b>	Shimano Deore 10-speed
<b>Brakes</b>	Shimano MT400 hydraulic
<b>Saddle</b>	Selle Royal Ariel
<b>Handlebar</b>	Promax 700 mm 31.8
<b>Handlebar stem</b>	Promax 0 - 40° / 90 mm
<b>Freewheel / Cassette</b>	Shimano CS-M4100 11-42T 10-speed
<b>Chain</b>	KMC E10
<b>Crank</b>	Ananda 46T
<b>Front hub</b>	Shimano TX505
<b>Rear hub</b>	Shimano TX505
<b>Bottom bracket</b>	-
<b>Pedals</b>	VP
<b>Grip</b>	Velo VLG-1189D3
<b>Front light</b>	Spaninga Kendo XE
<b>Rear light</b>	Spaninga MLL XE
<b>Seat post</b>	Promax 27.2 / 400 mm
<b>Max load</b>	125 kg
<b>Weight</b>	29 kg

<b>Type of motor</b>	Middrive
<b>Brand of motor</b>	Ananda
<b>Model of motor</b>	M100
<b>Nominal power of motor</b>	250 W

<b>Torque</b>	130 N.m
<b>Voltage</b>	48 V

<b>Type of battery</b>	Li-ion
<b>Battery power</b>	696 - 960 Wh
<b>Voltage</b>	48 V
<b>Range</b>	up to 150 km
<b>Cells brand</b>	LG / Greenway

<b>Display</b>	Color LCD
<b>Display brand</b>	Ecobike
<b>Display model</b>	C900









- A** 595 mm
- B** 145 mm
- C** 430 mm
- D** 1135.4 mm
- E** 72.5°
- F** 69°



ECOBIKE TREKKING  
**LX 500 Palm Blue**



Discover more

-  **29 kg**  
Weight
-  **250 W**  
Motor power
-  **696 - 960 Wh**  
Battery capacity
-  **150 km**  
Maximum range
-  **28"**  
Wheel
-  **19"**  
Frame

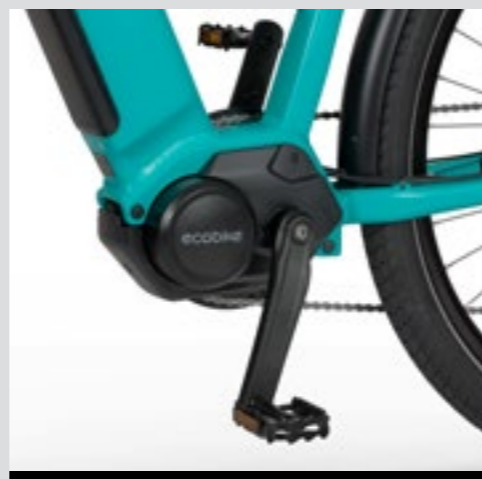
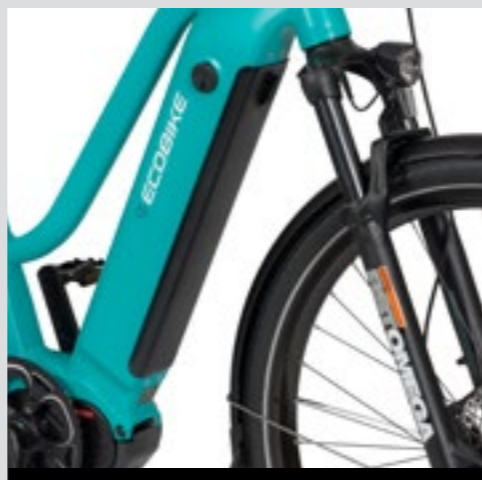
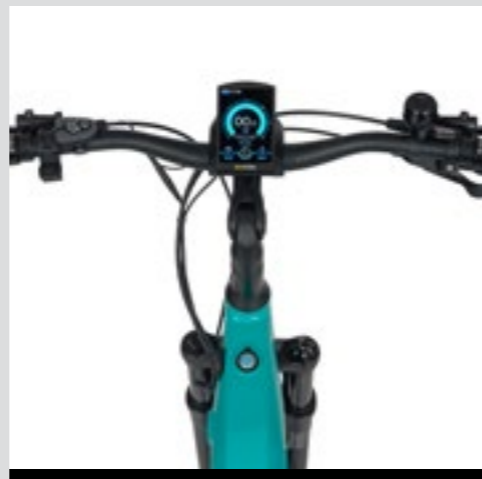

Specification

<b>Frame</b>	19" hydroformed aluminium
<b>Fork</b>	RST OMEGA-TNL-29" travel 100 mm
<b>Wheel</b>	28" reinforced three-chambered rims / Sapim spokes
<b>Tires</b>	28" x 2.15 Schwalbe Big Ben Plus
<b>Derailleur front</b>	-
<b>Derailleur rear</b>	Shimano Deore 10-speed
<b>Shifter</b>	Shimano Deore 10-speed
<b>Brakes</b>	Shimano MT400 hydraulic
<b>Saddle</b>	Selle Royal Ariel
<b>Handlebar</b>	Promax 700 mm 31.8
<b>Handlebar stem</b>	Promax 0 - 40° / 90 mm
<b>Freewheel / Cassette</b>	Shimano CS-M4100 11-42T 10-speed
<b>Chain</b>	KMC E10
<b>Crank</b>	Ananda 46T
<b>Front hub</b>	Shimano TX505
<b>Rear hub</b>	Shimano TX505
<b>Bottom bracket</b>	-
<b>Pedals</b>	VP
<b>Grip</b>	Velo VLG-1189D3
<b>Front light</b>	Spaninga Kendo XE
<b>Rear light</b>	Spaninga MLL XE
<b>Seat post</b>	Promax 27.2 / 400 mm
<b>Max load</b>	125 kg
<b>Weight</b>	29 kg

<b>Type of motor</b>	Middrive
<b>Brand of motor</b>	Ananda
<b>Model of motor</b>	M100
<b>Nominal power of motor</b>	250 W

<b>Torque</b>	130 N.m
<b>Voltage</b>	48 V

<b>Type of battery</b>	Li-ion
<b>Battery power</b>	696 - 960 Wh
<b>Voltage</b>	48 V
<b>Range</b>	up to 150 km
<b>Cells brand</b>	LG / Greenway

<b>Display</b>	Color LCD
<b>Display brand</b>	Ecobike
<b>Display model</b>	C900



- A** 595 mm
- B** 145 mm
- C** 482 mm
- D** 1135.4 mm
- E** 72.5°
- F** 69°









E-bike system

ECOBIKE TREKKING  
**MX 500 Blue**



Discover more

-  **29.1 kg**  
Weight
-  **250 W**  
Motor power
-  **696 - 960 Wh**  
Battery capacity
-  **150 km**  
Maximum range
-  **28"**  
Wheel
-  **20"**  
Frame

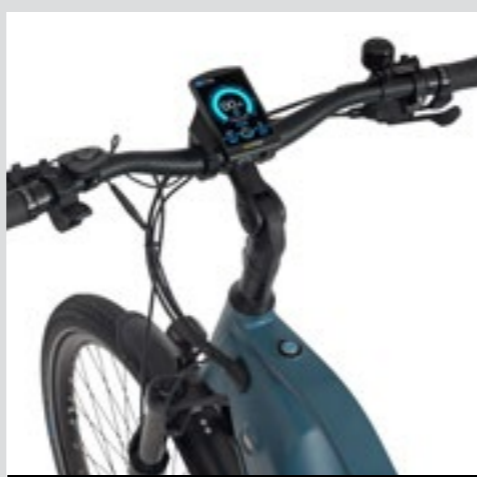
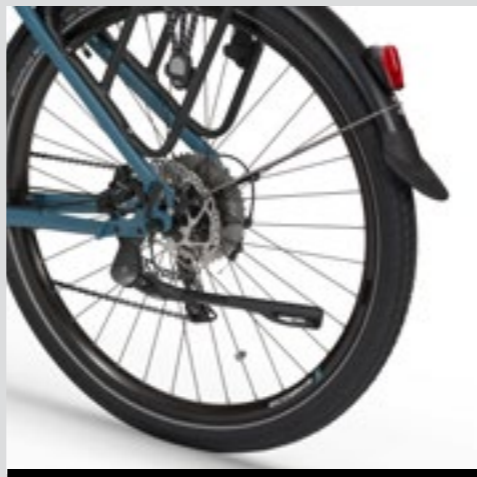

Specification

<b>Frame</b>	20" hydroformed aluminium
<b>Fork</b>	RST OMEGA-TNL-29" travel 100 mm
<b>Wheel</b>	28" reinforced three-chambered rims / Sapim spokes
<b>Tires</b>	28" x 2.15 Schwalbe Big Ben Plus
<b>Derailleur front</b>	-
<b>Derailleur rear</b>	Shimano Deore 10-speed
<b>Shifter</b>	Shimano Deore 10-speed
<b>Brakes</b>	Shimano MT400 hydraulic
<b>Saddle</b>	Selle Royal Ariel
<b>Handlebar</b>	Promax 700 mm 31.8
<b>Handlebar stem</b>	Promax 0 - 40° / 90 mm
<b>Freewheel / Cassette</b>	Shimano CS-M4100 11-42T 10-speed
<b>Chain</b>	KMC E10
<b>Crank</b>	Ananda 46T
<b>Front hub</b>	Shimano TX505
<b>Rear hub</b>	Shimano TX505
<b>Bottom bracket</b>	-
<b>Pedals</b>	VP
<b>Grip</b>	Velo VLG-1189D3
<b>Front light</b>	Spaninga Kendo XE
<b>Rear light</b>	Spaninga MLL XE
<b>Seat post</b>	Promax 27.2 / 350 mm
<b>Max load</b>	125 kg
<b>Weight</b>	29.1 kg

<b>Type of motor</b>	Middrive
<b>Brand of motor</b>	Ananda
<b>Model of motor</b>	M100
<b>Nominal power of motor</b>	250 W

<b>Torque</b>	130 N.m
<b>Voltage</b>	48 V

<b>Type of battery</b>	Li-ion
<b>Battery power</b>	696 - 960 Wh
<b>Voltage</b>	48 V
<b>Range</b>	up to 150 km
<b>Cells brand</b>	LG / Greenway

<b>Display</b>	Color LCD
<b>Display brand</b>	Ecobike
<b>Display model</b>	C900



- A** 610 mm
- B** 145 mm
- C** 508 mm
- D** 1162.7 mm
- E** 72.5°
- F** 69°



E-bike system



ecobike

#READY  
TO  
ECO

# — CITY

Feel free in the urban jungle.  
Avoid traffic jams and get  
to wherever you want - quickly!

Start saving real money on fuel and  
car insurance. Never worry about  
a parking space again. And most  
of all, care about your environment.



ECOBIKE CITY  
**Urban**



**16.9 kg**  
Weight



**250 W**  
Motor power



**349.2 Wh**  
Battery capacity



**80 km**  
Maximum range



**28"**  
Wheel



**19"**  
Frame



Discover more

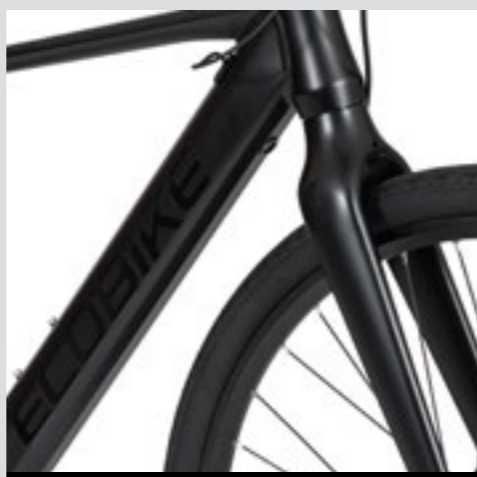
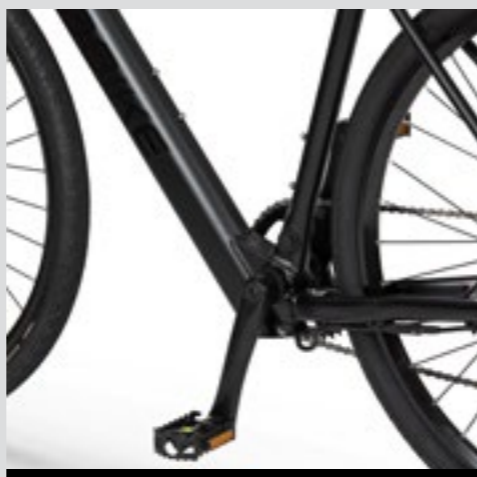

Specification

E-bike system

<b>Frame</b>	19" hydroformed aluminium
<b>Fork</b>	aluminium
<b>Wheel</b>	28" reinforced three-chambered rims / Sapim spokes
<b>Tires</b>	28" x 1.75 Vittoria City Randonneur
<b>Derailleur front</b>	-
<b>Derailleur rear</b>	Shimano Alivio 9-speed
<b>Shifter</b>	Shimano Altus 9-speed
<b>Brakes</b>	Tektro HD M275 hydraulic
<b>Saddle</b>	Velo VL-3381
<b>Handlebar</b>	Zoom 720 mm 31.8
<b>Handlebar stem</b>	Zoom 7° / 70 mm
<b>Freewheel / Cassette</b>	Shimano HG-200 11-36T 9-speed
<b>Chain</b>	KMC e9
<b>Crank</b>	Prowheel 44T
<b>Front hub</b>	KT-XA2F
<b>Rear hub</b>	Motor
<b>Bottom bracket</b>	Bafang
<b>Pedals</b>	VP
<b>Grip</b>	Velo VLG 709-2AD3
<b>Front light</b>	-
<b>Rear light</b>	-
<b>Seat post</b>	Zoom 27.2 / 300 mm
<b>Max load</b>	125 kg
<b>Weight</b>	16.9 kg

<b>Type of motor</b>	Rear hub motor
<b>Brand of motor</b>	Bafang
<b>Model of motor</b>	RM G370 250 DC
<b>Nominal power of motor</b>	250 W

<b>Torque</b>	30 N.m
<b>Voltage</b>	36 V

<b>Type of battery</b>	Li-ion
<b>Battery power</b>	349,2 Wh
<b>Voltage</b>	36 V
<b>Range</b>	up to 80 km
<b>Cells brand</b>	Greenway

<b>Display</b>	Monochromatic LCD
<b>Display brand</b>	Bafang
<b>Display model</b>	C240 CAN

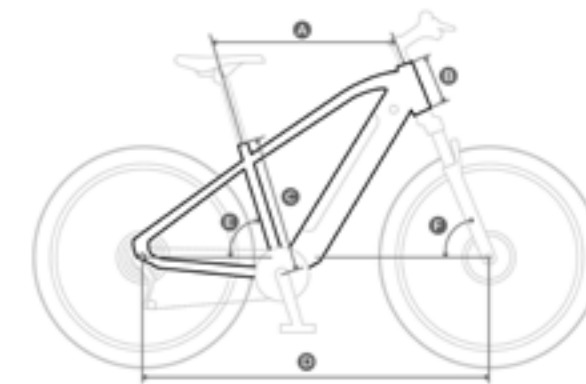







- A 590 mm
- B 120 mm
- C 490 mm
- D 1087.5 mm
- E 74°
- F 70.5°



ECOBIKE CITY  
**X-City Coffee**



Discover more

-  **26.5 kg**  
Weight
-  **250 W**  
Motor power
-  **522 – 630 Wh**  
Battery capacity
-  **110 km**  
Maximum range
-  **28"**  
Wheel
-  **19"**  
Frame

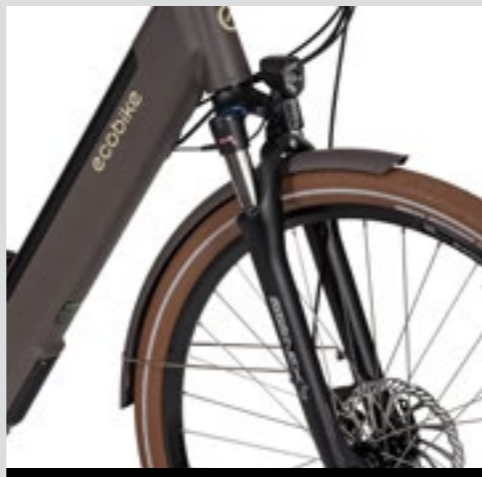
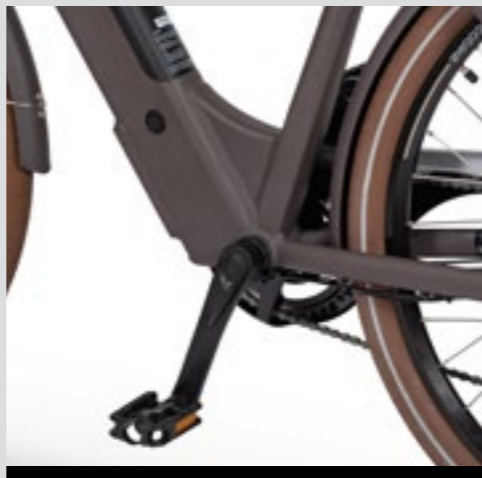

Specification

<b>Frame</b>	19" hydroformed aluminium
<b>Fork</b>	SunTour SF15 NEX-E25 travel 63 mm
<b>Wheel</b>	28" reinforced three-chambered rims / Sapim spokes
<b>Tires</b>	28" x 2.0 Mitas Cityhopper brown
<b>Derailleur front</b>	-
<b>Derailleur rear</b>	Shimano Acera 8-speed
<b>Shifter</b>	Shimano Tourney Revo 8-speed
<b>Brakes</b>	Bengal MB 500 mechanical
<b>Saddle</b>	Selle Royal Lookin Basic
<b>Handlebar</b>	Promax 600 mm 25.4
<b>Handlebar stem</b>	Zoom 30° / 105 mm
<b>Freewheel / Cassette</b>	SunRace MFM3A 11-32T 8-speed
<b>Chain</b>	KMC
<b>Crank</b>	Prowheel 44T
<b>Front hub</b>	KT-K68F
<b>Rear hub</b>	Motor
<b>Bottom bracket</b>	Feimin FP-B902W
<b>Pedals</b>	WELLGO
<b>Grip</b>	Velo VLG 519AD2
<b>Front light</b>	Spaninga Kendo XE
<b>Rear light</b>	Spaninga RL1900XE DC36V E-BIKE
<b>Seat post</b>	Promax 27.2 / 350 mm
<b>Max load</b>	125 kg
<b>Weight</b>	26.5 kg

<b>Type of motor</b>	Rear hub motor
<b>Brand of motor</b>	Bafang
<b>Model of motor</b>	SWX02
<b>Nominal power of motor</b>	250 W

<b>Torque</b>	45 N.m
<b>Voltage</b>	36 V

<b>Type of battery</b>	Li-ion
<b>Battery power</b>	522 – 630 Wh
<b>Voltage</b>	36 V
<b>Range</b>	up to 110 km
<b>Cells brand</b>	Greenway

<b>Display</b>	Monochromatic LCD
<b>Display brand</b>	Ecobike
<b>Display model</b>	C600E

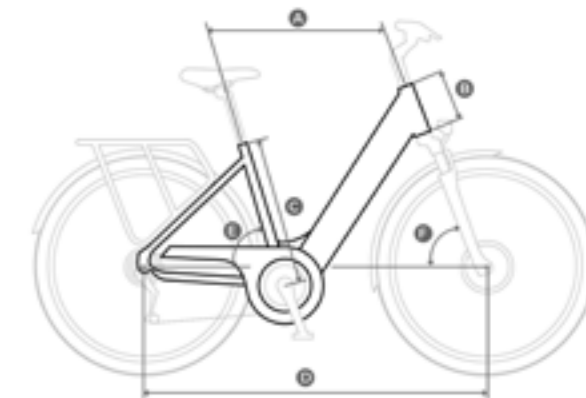

- A** 588.2 mm
- B** 160 mm
- C** 482 mm
- D** 1108.6 mm
- E** 73.2°
- F** 70°









E-bike system



ECOBIKE CITY  
**X-City Cappuccino**



Discover more

-  **26.5 kg**  
Weight
-  **250 W**  
Motor power
-  **522 – 630 Wh**  
Battery capacity
-  **110 km**  
Maximum range
-  **28"**  
Wheel
-  **17"**  
Frame

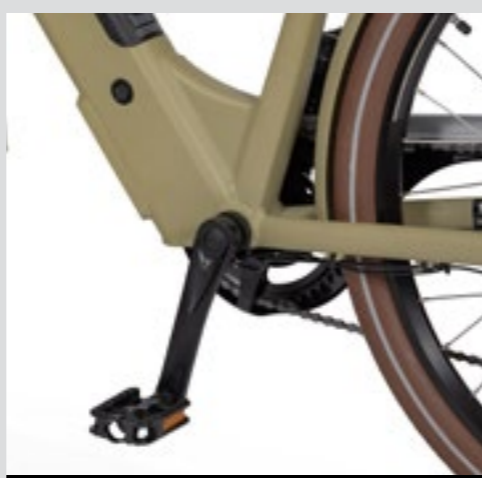
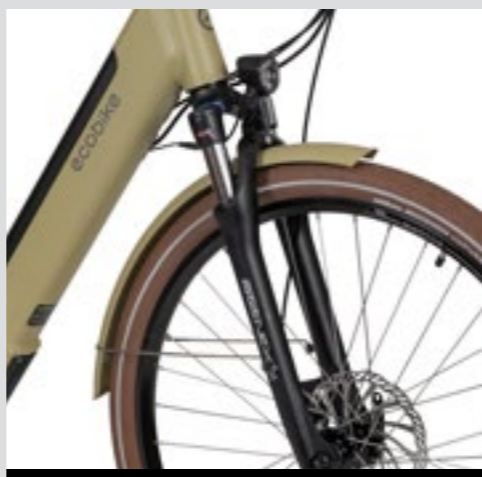
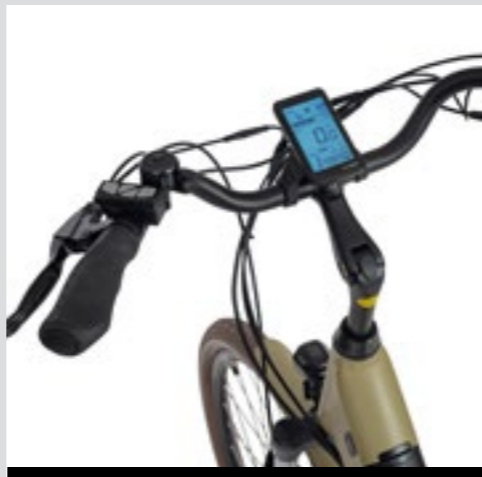

Specification

<b>Frame</b>	17" hydroformed aluminium
<b>Fork</b>	SunTour SF15 NEX-E25 travel 63 mm
<b>Wheel</b>	28" reinforced three-chambered rims / Sapim spokes
<b>Tires</b>	28" x 2.0 Mitas Cityhopper brown
<b>Derailleur front</b>	-
<b>Derailleur rear</b>	Shimano Acera 8-speed
<b>Shifter</b>	Shimano Tourney Revo 8-speed
<b>Brakes</b>	Bengal MB 500 mechanical
<b>Saddle</b>	Selle Royal Lookin Basic
<b>Handlebar</b>	Promax 600 mm 25.4
<b>Handlebar stem</b>	Zoom 30° / 105 mm
<b>Freewheel / Cassette</b>	SunRace MFM3A 11-32T 8-speed
<b>Chain</b>	KMC
<b>Crank</b>	Prowheel 44T
<b>Front hub</b>	KT-K68F
<b>Rear hub</b>	Motor
<b>Bottom bracket</b>	Feimin FP-B902W
<b>Pedals</b>	WELLGO
<b>Grip</b>	Velo VLG 519AD2
<b>Front light</b>	Spaninga Kendo XE
<b>Rear light</b>	Spaninga RL1900XE DC36V E-BIKE
<b>Seat post</b>	Promax 27.2 / 350 mm
<b>Max load</b>	125 kg
<b>Weight</b>	26.5 kg

<b>Type of motor</b>	Rear hub motor
<b>Brand of motor</b>	Bafang
<b>Model of motor</b>	SWX02
<b>Nominal power of motor</b>	250 W

<b>Torque</b>	45 N.m
<b>Voltage</b>	36 V

<b>Type of battery</b>	Li-ion
<b>Battery power</b>	522 – 630 Wh
<b>Voltage</b>	36 V
<b>Range</b>	up to 110 km
<b>Cells brand</b>	Greenway

<b>Display</b>	Monochromatic LCD
<b>Display brand</b>	Ecobike
<b>Display model</b>	C600E

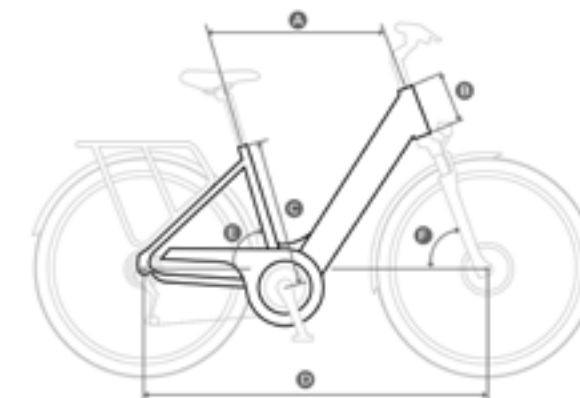

- A** 590 mm
- B** 160 mm
- C** 432 mm
- D** 1108,6 mm
- E** 73°
- F** 70°









E-bike system

ECOBIKE TREKKING  
**D2 City Menthol**



Discover more



-  **27.3 kg**  
Weight
-  **250 W**  
Motor power
-  **672 Wh**  
Battery capacity
-  **130 km**  
Maximum range
-  **28"**  
Wheel
-  **17"**  
Frame

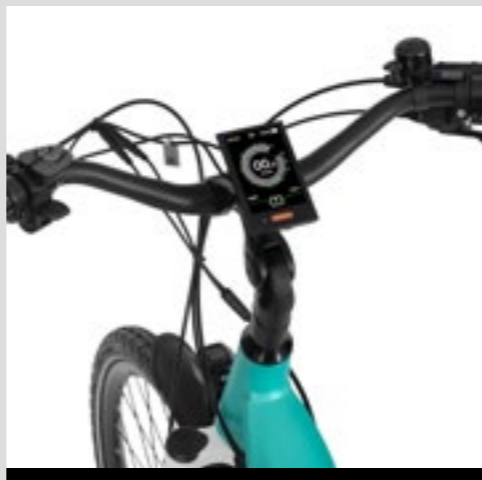

Specification

<b>Frame</b>	17" hydroformed aluminium
<b>Fork</b>	SunTour SF15 NEX-E25 travel 63 mm
<b>Wheel</b>	28" reinforced three-chambered rims / Sapim spokes
<b>Tires</b>	28" x 1.75 CST XPEDIUM C1880 / 28" x 1.95 TRC INDIGO
<b>Derailleur front</b>	-
<b>Derailleur rear</b>	Shimano Deore 10-speed
<b>Shifter</b>	Shimano Deore 10-speed
<b>Brakes</b>	Alhonga HJ-HT472 hydraulic
<b>Saddle</b>	Velo VL-8089E
<b>Handlebar</b>	Promax 700 mm 31.8
<b>Handlebar stem</b>	Promax 0 - 40° / 90 mm
<b>Freewheel / Cassette</b>	Shimano CS-M4100 11-42T 10-speed
<b>Chain</b>	KMC
<b>Crank</b>	Bafang 44T
<b>Front hub</b>	KT-SN6F
<b>Rear hub</b>	KT-SN6R
<b>Bottom bracket</b>	Bafang
<b>Pedals</b>	VP
<b>Grip</b>	Velo VLG-1189AD3
<b>Front light</b>	Spaninga Kendo XE
<b>Rear light</b>	Spaninga MLL XE
<b>Seat post</b>	Promax 27.2 / 350 mm
<b>Max load</b>	125 kg
<b>Weight</b>	27.3 kg

<b>Type of motor</b>	Middrive
<b>Brand of motor</b>	Bafang
<b>Model of motor</b>	M420
<b>Nominal power of motor</b>	250 W

<b>Torque</b>	80 N.m
<b>Voltage</b>	48 V

<b>Type of battery</b>	Li-ion
<b>Battery power</b>	672 Wh
<b>Voltage</b>	48 V
<b>Range</b>	up to 130 km
<b>Cells brand</b>	LG

<b>Display</b>	Color LCD
<b>Display brand</b>	Bafang
<b>Display model</b>	C18

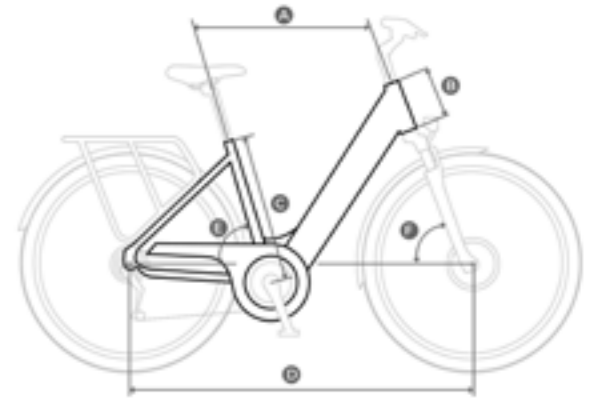

- A 615 mm
- B 150 mm
- C 432 mm
- D 1132.6 mm
- E 73°
- F 70°









E-bike system

ECOBIKE TREKKING  
**D2 City Black**



Discover more



-  **27.3 kg**  
Weight
-  **250 W**  
Motor power
-  **672 Wh**  
Battery capacity
-  **130 km**  
Maximum range
-  **28"**  
Wheel
-  **19"**  
Frame

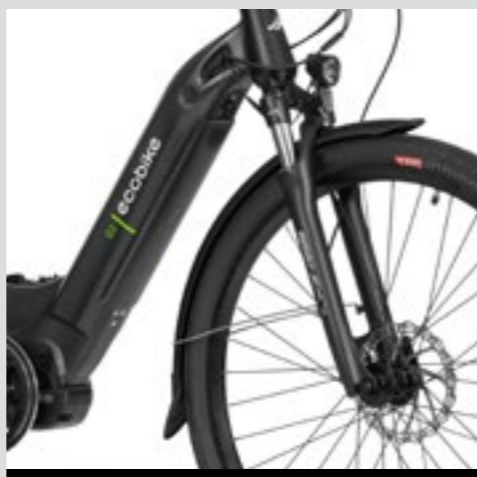
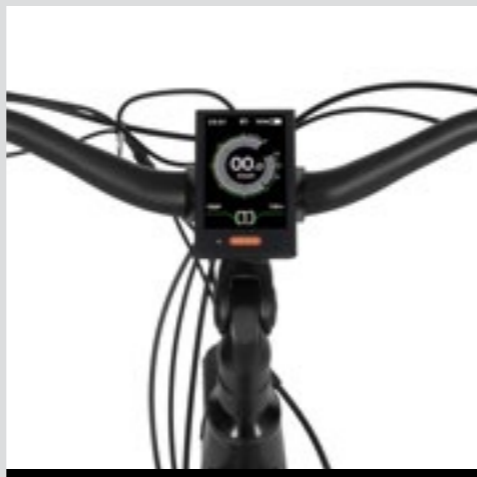

E-bike system Specification

<b>Frame</b>	19" hydroformed aluminium
<b>Fork</b>	SunTour SF15 NEX-E25 travel 63 mm
<b>Wheel</b>	28" reinforced three-chambered rims / Sapim spokes
<b>Tires</b>	28" x 1.75 CST XPEDIUM C1880 / 28" x 1.95 TRC INDIGO
<b>Derailleur front</b>	-
<b>Derailleur rear</b>	Shimano Deore 10-speed
<b>Shifter</b>	Shimano Deore 10-speed
<b>Brakes</b>	Alhonga HJ-HT472 hydraulic
<b>Saddle</b>	Velo VL-8089E
<b>Handlebar</b>	Promax 700 mm 31.8
<b>Handlebar stem</b>	Promax 0 - 40° / 90 mm
<b>Freewheel / Cassette</b>	Shimano CS-M4100 11-42T 10-speed
<b>Chain</b>	KMC
<b>Crank</b>	Bafang 44T
<b>Front hub</b>	KT-SN6F
<b>Rear hub</b>	KT-SN6R
<b>Bottom bracket</b>	Bafang
<b>Pedals</b>	VP
<b>Grip</b>	Velo VLG-1189AD3
<b>Front light</b>	Spaninga Kendo XE
<b>Rear light</b>	Spaninga MLL XE
<b>Seat post</b>	Promax 27.2 / 350 mm
<b>Max load</b>	125 kg
<b>Weight</b>	27.3 kg
<b>Type of motor</b>	Middrive
<b>Brand of motor</b>	Bafang
<b>Model of motor</b>	M420
<b>Nominal power of motor</b>	250 W
<b>Torque</b>	80 N.m
<b>Voltage</b>	48 V
<b>Type of battery</b>	Li-ion
<b>Battery power</b>	672 Wh
<b>Voltage</b>	48 V
<b>Range</b>	up to 130 km
<b>Cells brand</b>	LG
<b>Display</b>	Color LCD
<b>Display brand</b>	Bafang
<b>Display model</b>	C18



- A 615 mm
- B 150 mm
- C 482 mm
- D 1132.6 mm
- E 73°
- F 70°







# ECOBIKE CITY

## Cargo



Discover more

-  **30.9 kg**  
Weight
-  **250 W**  
Motor power
-  **556,8 Wh + 768 Wh**  
Battery capacity
-  **180 km**  
Maximum range
-  **20" + 24"**  
Wheel
-  **19"**  
Frame

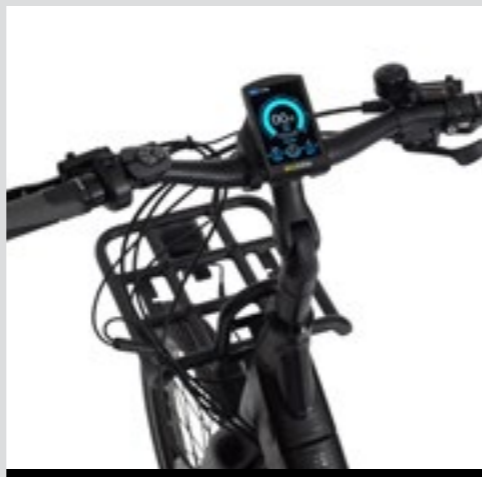

### Specification

<b>Frame</b>	19" hydroformed aluminium
<b>Fork</b>	aluminium
<b>Wheel</b>	24" and 20" reinforced three-chambered rims / Sapim spokes
<b>Tires</b>	24" and 20" x 2.0 Schwalbe Big Ben Plus
<b>Derailleur front</b>	-
<b>Derailleur rear</b>	Microshift Marvo 9-speed
<b>Shifter</b>	Microshift Marvo 9-speed
<b>Brakes</b>	Shimano MT200 hydraulic
<b>Saddle</b>	Selle Royal Freeway
<b>Handlebar</b>	Promax 640 mm 31.8
<b>Handlebar stem</b>	Promax 90 mm
<b>Freewheel / Cassette</b>	Microshift CS-H092 11-36T 9-speed
<b>Chain</b>	KMC e9
<b>Crank</b>	Ananda 42T
<b>Front hub</b>	Shimano TX505 / NEXELO
<b>Rear hub</b>	Shimano TX505 / NEXELO
<b>Bottom bracket</b>	-
<b>Pedals</b>	VP
<b>Grip</b>	Velo VLG-776
<b>Front light</b>	Spaninga HL4310 XE 6-36VDC E-Bike Version
<b>Rear light</b>	Spaninga RLL XE.6VDC E-BIKE Version
<b>Seat post</b>	Promax 27.2 / 350 mm
<b>Max load</b>	155 kg
<b>Weight</b>	30.9 kg
<b>Type of motor</b>	Midrive
<b>Brand of motor</b>	Ananda
<b>Model of motor</b>	M100
<b>Nominal power of motor</b>	250 W
<b>Torque</b>	130 N.m
<b>Voltage</b>	48 V
<b>Type of battery</b>	Li-ion
<b>Battery power</b>	556,8 Wh + 768 Wh
<b>Voltage</b>	48 V
<b>Range</b>	up to 180 km
<b>Cells brand</b>	LG / Greenway
<b>Display</b>	Color LCD
<b>Display brand</b>	Ecobike
<b>Display model</b>	C900



- A 628.8 mm
- B 210 mm
- C 483.9 mm
- D 1240 mm
- E 73°
- F 71°







Available with an optional 90-litre box



ECOBIKE CITY  
**Basic Black**



Discover more

-  **21.3 kg**  
Weight
-  **250 W**  
Motor power
-  **313.2 - 630 Wh**  
Battery capacity
-  **140 km**  
Maximum range
-  **28"**  
Wheel
-  **19"**  
Frame



Specification

<b>Frame</b>	19" hydroformed aluminium
<b>Fork</b>	Steel
<b>Wheel</b>	28" reinforced three-chambered rims / Sapim spokes
<b>Tires</b>	28" x 1.75 Impac StreetPac
<b>Derailleur front</b>	-
<b>Derailleur rear</b>	Shimano Tourney 6-speed
<b>Shifter</b>	Shimano Tourney Revo 6-speed
<b>Brakes</b>	Promax TX 117 V-brakes
<b>Saddle</b>	Aifeit
<b>Handlebar</b>	Promax 600 mm 25.4
<b>Handlebar stem</b>	Promax 105 mm
<b>Freewheel / Cassette</b>	Shimano MF-TZ500 14-28T 6-speed
<b>Chain</b>	KMC
<b>Crank</b>	Prowheel 42T
<b>Front hub</b>	Joytech 751DSE
<b>Rear hub</b>	Motor
<b>Bottom bracket</b>	Feimin FP-B902W
<b>Pedals</b>	VP
<b>Grip</b>	Velo VLG 519AD2
<b>Front light</b>	Spaninga HL1900XE 36V E-BIKE
<b>Rear light</b>	Spaninga RL1900XE DC36V E-BIKE
<b>Seat post</b>	Promax 27.2 / 350 mm
<b>Max load</b>	125 kg
<b>Weight</b>	21.3 kg

<b>Type of motor</b>	Rear hub motor
<b>Brand of motor</b>	XOFO
<b>Model of motor</b>	SOFD-135
<b>Nominal power of motor</b>	250 W

<b>Torque</b>	32 N.m
<b>Voltage</b>	36 V

<b>Type of battery</b>	Li-ion
<b>Battery power</b>	313,2 - 630 Wh
<b>Voltage</b>	36 V
<b>Range</b>	up to 140 km
<b>Cells brand</b>	LG / Greenway

<b>Display</b>	LED display
<b>Display brand</b>	Kingmeter
<b>Display model</b>	792-36L



- A** 601.8 mm
- B** 161 mm
- C** 482 mm
- D** 1105.7 mm
- E** 72.5°
- F** 70°



E-bike system

ECOBIKE CITY

# Basic Petrol Blue



Discover more

- 21.1 kg**  
Weight
- 250 W**  
Motor power
- 313.2 - 630 Wh**  
Battery capacity
- 140 km**  
Maximum range
- 28"**  
Wheel
- 17"**  
Frame

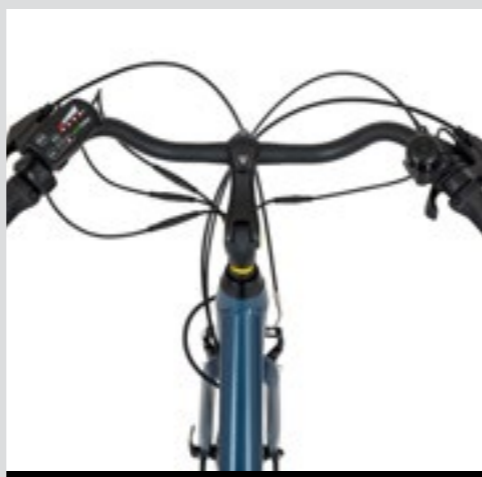
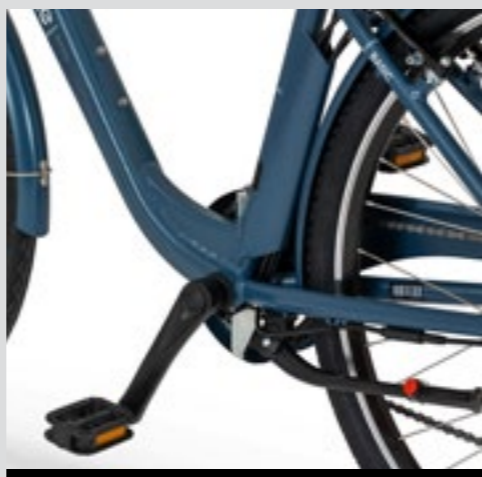

Specification

<b>Frame</b>	17" hydroformed aluminium
<b>Fork</b>	Steel
<b>Wheel</b>	28" reinforced three-chambered rims / Sapim spokes
<b>Tires</b>	28" x 1.75 Wanda
<b>Derailleur front</b>	-
<b>Derailleur rear</b>	Shimano Tourney 6-speed
<b>Shifter</b>	Shimano Tourney Revo 6-speed
<b>Brakes</b>	Promax TX 117 V-brakes
<b>Saddle</b>	Aifeit
<b>Handlebar</b>	Promax 600 mm 25.4
<b>Handlebar stem</b>	Promax 105 mm
<b>Freewheel / Cassette</b>	Shimano MF-TZ500 14-28T 6-speed
<b>Chain</b>	KMC
<b>Crank</b>	Prowheel 42T
<b>Front hub</b>	Joytech 751DSE
<b>Rear hub</b>	Motor
<b>Bottom bracket</b>	Feimin FP-B902W
<b>Pedals</b>	VP
<b>Grip</b>	Velo VLG 519AD2
<b>Front light</b>	Spaninga HL1900XE 36V E-BIKE
<b>Rear light</b>	Spaninga RL1900XE DC36V E-BIKE
<b>Seat post</b>	Promax 27.2 / 350 mm
<b>Max load</b>	125 kg
<b>Weight</b>	21.1 kg

<b>Type of motor</b>	Rear hub motor
<b>Brand of motor</b>	XOFO
<b>Model of motor</b>	SOFD-135
<b>Nominal power of motor</b>	250 W

<b>Torque</b>	32 N.m
<b>Voltage</b>	36V

<b>Type of battery</b>	Li-ion
<b>Battery power</b>	313,2 - 630 Wh
<b>Voltage</b>	36V
<b>Range</b>	up to 140 km
<b>Cells brand</b>	LG / Greenway

<b>Display</b>	LED display
<b>Display brand</b>	Kingmeter
<b>Display model</b>	792-36L



- A** 601.2 mm
- B** 180 mm
- C** 432 mm
- D** 1105.7 mm
- E** 73°
- F** 70°









ECOBIKE CITY

# Basic Nexus White



Discover more

-  **23 kg**  
Weight
-  **250 W**  
Motor power
-  **313.2 - 630 Wh**  
Battery capacity
-  **140 km**  
Maximum range
-  **28"**  
Wheel
-  **17"**  
Frame

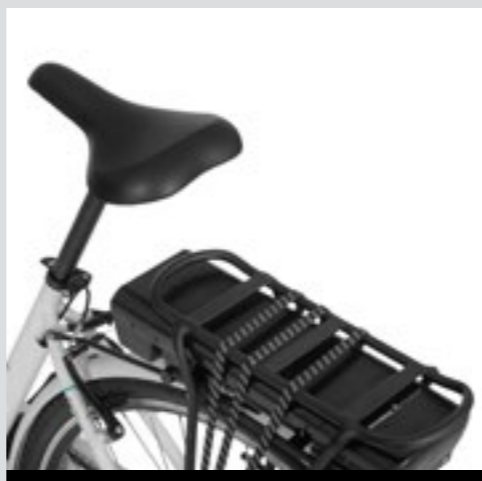
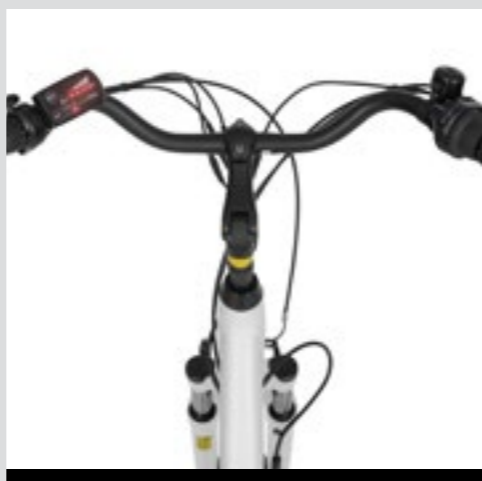

Specification

<b>Frame</b>	17" hydroformed aluminium
<b>Fork</b>	SunTour SF14 CR8V P travel 63 mm
<b>Wheel</b>	28" reinforced three-chambered rims / Sapim spokes
<b>Tires</b>	28" x 1.75 Impac StreetPac
<b>Derailleur front</b>	-
<b>Derailleur rear</b>	Shimano NEXUS 3-speed
<b>Shifter</b>	Shimano NEXUS Revo 3-speed
<b>Brakes</b>	Promax TX 117 V-brakes
<b>Saddle</b>	Aifeit
<b>Handlebar</b>	Promax 600 mm 25.4
<b>Handlebar stem</b>	Promax 105 mm
<b>Freewheel / Cassette</b>	Shimano NEXUS 20T
<b>Chain</b>	KMC
<b>Crank</b>	Prowheel 42T
<b>Front hub</b>	Motor
<b>Rear hub</b>	Shimano NEXUS
<b>Bottom bracket</b>	Feimin FP-B902W
<b>Pedals</b>	VP
<b>Grip</b>	Velo VLG 519AD2
<b>Front light</b>	Spaninga HL1900XE 36V E-BIKE
<b>Rear light</b>	Spaninga RL1900XE DC36V E-BIKE
<b>Seat post</b>	Promax 27.2 / 350 mm
<b>Max load</b>	125 kg
<b>Weight</b>	23 kg

<b>Type of motor</b>	Front hub motor
<b>Brand of motor</b>	XOFO
<b>Model of motor</b>	XF-D
<b>Nominal power of motor</b>	250 W

<b>Torque</b>	32 N.m
<b>Voltage</b>	36 V

<b>Type of battery</b>	Li-ion
<b>Battery power</b>	313,2 - 630 Wh
<b>Voltage</b>	36 V
<b>Range</b>	up to 140 km
<b>Cells brand</b>	LG / Greenway

<b>Display</b>	LED display
<b>Display brand</b>	Kingmeter
<b>Display model</b>	792-36L



- A** 601.6 mm
- B** 180 mm
- C** 432 mm
- D** 1108.4 mm
- E** 72.5°
- F** 70°



E-bike system

ECOBIKE CITY

# Basic Nexus Blue



Discover more

- 23.1 kg**  
Weight
- 250 W**  
Motor power
- 313.2 - 630 Wh**  
Battery capacity
- 140 km**  
Maximum range
- 28"**  
Wheel
- 19"**  
Frame

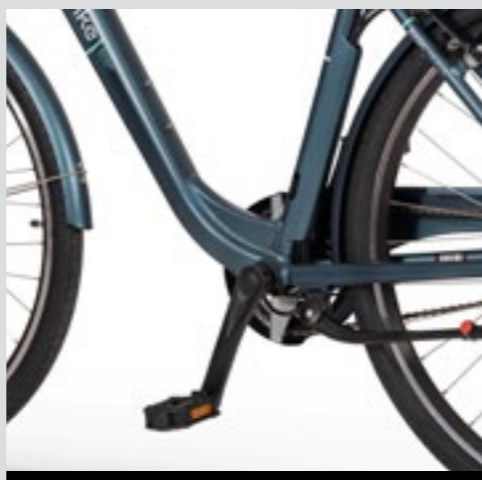
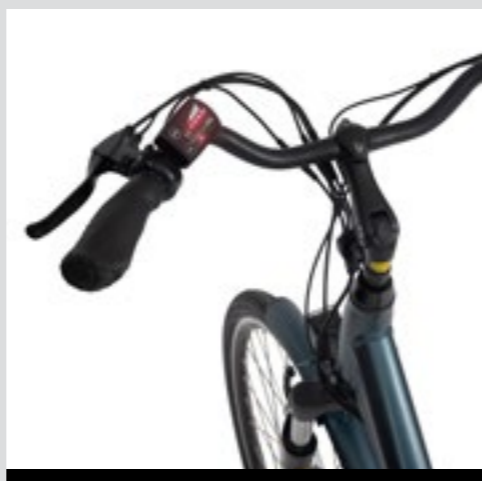
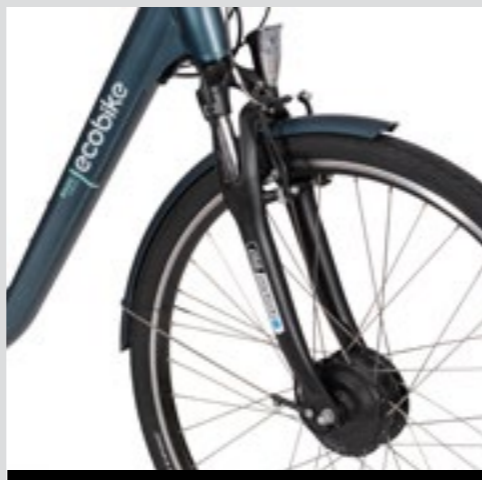

Specification

E-bike system

<b>Frame</b>	19" hydroformed aluminium
<b>Fork</b>	SunTour SF14 CR8V P travel 63 mm
<b>Wheel</b>	28" reinforced three-chambered rims / Sapim spokes
<b>Tires</b>	28" x 1.75 Impac StreetPac
<b>Derailleur front</b>	-
<b>Derailleur rear</b>	Shimano NEXUS 3-speed
<b>Shifter</b>	Shimano NEXUS Revo 3-speed
<b>Brakes</b>	Promax TX 117 V-brakes
<b>Saddle</b>	Aifeit
<b>Handlebar</b>	Promax 600 mm 25.4
<b>Handlebar stem</b>	Promax 105 mm
<b>Freewheel / Cassette</b>	Shimano NEXUS 20T
<b>Chain</b>	KMC
<b>Crank</b>	Prowheel 42T
<b>Front hub</b>	Motor
<b>Rear hub</b>	Shimano NEXUS
<b>Bottom bracket</b>	Feimin FP-B902W
<b>Pedals</b>	VP
<b>Grip</b>	Velo VLG 519AD2
<b>Front light</b>	Spaninga HL1900XE 36V E-BIKE
<b>Rear light</b>	Spaninga RL1900XE DC36V E-BIKE
<b>Seat post</b>	Promax 27.2 / 350 mm
<b>Max load</b>	125 kg
<b>Weight</b>	23.1 kg

<b>Type of motor</b>	Front hub motor
<b>Brand of motor</b>	XOFO
<b>Model of motor</b>	XF-D
<b>Nominal power of motor</b>	250 W

<b>Torque</b>	32 N.m
<b>Voltage</b>	36 V

<b>Type of battery</b>	Li-ion
<b>Battery power</b>	313,2 - 630 Wh
<b>Voltage</b>	36 V
<b>Range</b>	up to 140 km
<b>Cells brand</b>	LG / Greenway

<b>Display</b>	LED display
<b>Display brand</b>	Kingmeter
<b>Display model</b>	792-36L



- A 601.6 mm
- B 180 mm
- C 482 mm
- D 1108.4 mm
- E 72.5°
- F 70°













ECOBIKE CITY  
**Traffic Black**



Discover more

-  **24.3 kg**  
Weight
-  **250 W**  
Motor power
-  **417.6 - 630 Wh**  
Battery capacity
-  **140 km**  
Maximum range
-  **28"**  
Wheel
-  **19"**  
Frame

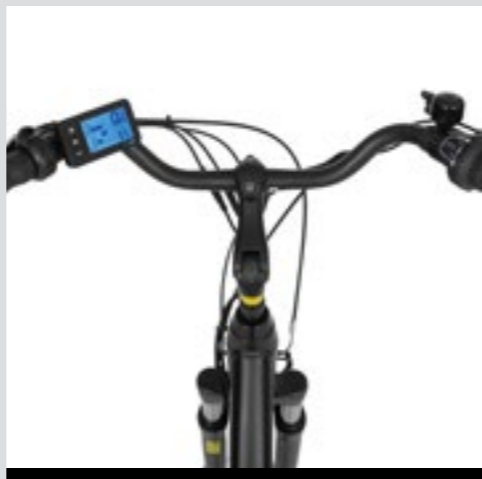
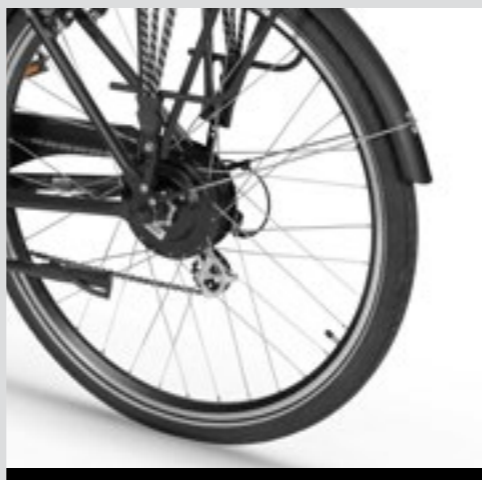
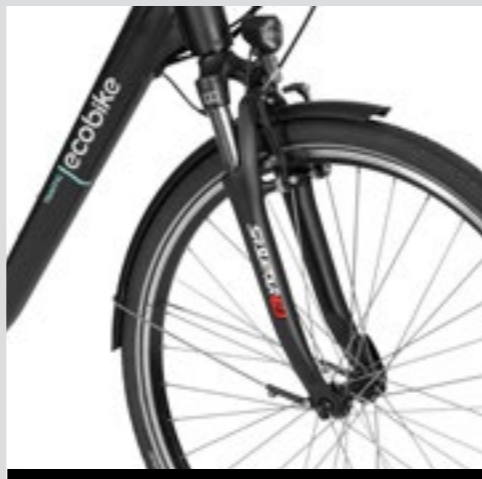

Specification

<b>Frame</b>	19" hydroformed aluminium
<b>Fork</b>	SunTour SF14 CR8V P travel 63 mm
<b>Wheel</b>	28" reinforced three-chambered rims / Sapim spokes
<b>Tires</b>	28" x 1.75 Impac StreetPac / Rubena Flash
<b>Derailleur front</b>	-
<b>Derailleur rear</b>	Shimano Altus 7-speed
<b>Shifter</b>	Shimano Tourney Revo 7-speed
<b>Brakes</b>	Promax TX 117 V-brakes
<b>Saddle</b>	Selle Royal Lookin Basic
<b>Handlebar</b>	Promax 600 mm 25.4
<b>Handlebar stem</b>	Promax 105 mm
<b>Freewheel / Cassette</b>	Shimano MF-TZ500 14-28T 7-speed
<b>Chain</b>	KMC z7
<b>Crank</b>	Prowheel 42T
<b>Front hub</b>	Joytech 751DSE
<b>Rear hub</b>	Motor
<b>Bottom bracket</b>	Feimin FP-B902W
<b>Pedals</b>	WELLGO
<b>Grip</b>	Velo VLG 519AD2
<b>Front light</b>	Spaninga Kendo XE
<b>Rear light</b>	Spaninga RL1900XE DC36V E-BIKE
<b>Seat post</b>	Promax 27.2 / 350 mm
<b>Max load</b>	125 kg
<b>Weight</b>	24.3 kg

<b>Type of motor</b>	Rear hub motor
<b>Brand of motor</b>	Bafang
<b>Model of motor</b>	SWX02
<b>Nominal power of motor</b>	250 W

<b>Torque</b>	45 N.m
<b>Voltage</b>	36 V

<b>Type of battery</b>	Li-ion
<b>Battery power</b>	417,6 - 630 Wh
<b>Voltage</b>	36 V
<b>Range</b>	up to 140 km
<b>Cells brand</b>	LG / Greenway

<b>Display</b>	Monochromatic LCD
<b>Display brand</b>	Ecobike
<b>Display model</b>	C300U



- A** 600.4 mm
- B** 161 mm
- C** 482 mm
- D** 1105.7 mm
- E** 72.5°
- F** 70°



ECOBIKE CITY

# Traffic White



Discover more

- 24.1 kg**  
Weight
- 250 W**  
Motor power
- 417.6 - 630 Wh**  
Battery capacity
- 140 km**  
Maximum range
- 28"**  
Wheel
- 17"**  
Frame

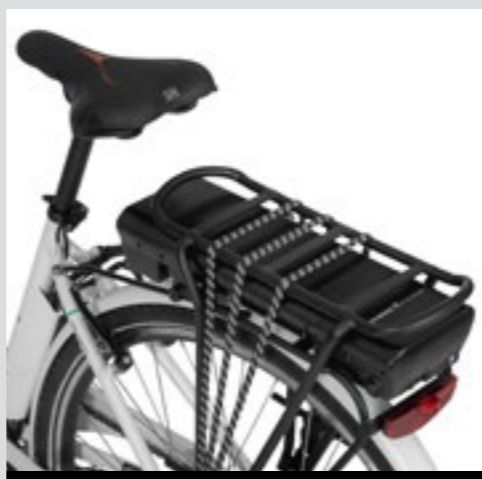
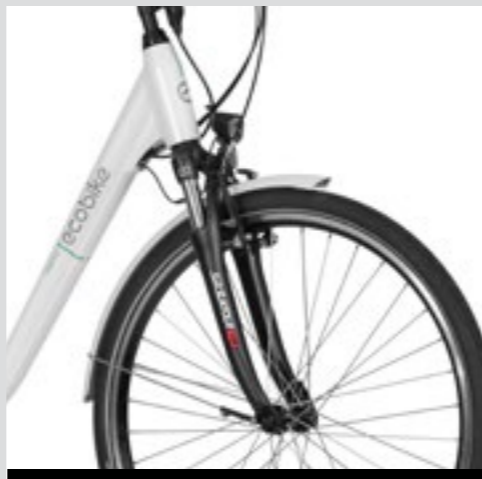

Specification

E-bike system

<b>Frame</b>	17" hydroformed aluminium
<b>Fork</b>	SunTour SF14 CR8V P travel 63 mm
<b>Wheel</b>	28" reinforced three-chambered rims / Sapim spokes
<b>Tires</b>	28" x 1.75 Impac StreetPac / Rubena Flash
<b>Derailleur front</b>	-
<b>Derailleur rear</b>	Shimano Altus 7-speed
<b>Shifter</b>	Shimano Tourney Revo 7-speed
<b>Brakes</b>	Promax TX 117 V-brakes
<b>Saddle</b>	Selle Royal Lookin Basic
<b>Handlebar</b>	Promax 600 mm 25.4
<b>Handlebar stem</b>	Promax 105 mm
<b>Freewheel / Cassette</b>	Shimano MF-TZ500 14-28T 7-speed
<b>Chain</b>	KMC z7
<b>Crank</b>	Prowheel 42T
<b>Front hub</b>	Joytech 751DSE
<b>Rear hub</b>	Motor
<b>Bottom bracket</b>	Feimin FP-B902W
<b>Pedals</b>	WELLGO
<b>Grip</b>	Velo VLG 519AD2
<b>Front light</b>	Spaninga Kendo XE
<b>Rear light</b>	Spaninga RL1900XE DC36V E-BIKE
<b>Seat post</b>	Promax 27.2 / 350 mm
<b>Max load</b>	125 kg
<b>Weight</b>	24.1 kg

<b>Type of motor</b>	Rear hub motor
<b>Brand of motor</b>	Bafang
<b>Model of motor</b>	SWX02
<b>Nominal power of motor</b>	250 W

<b>Torque</b>	45 N.m
<b>Voltage</b>	36 V

<b>Type of battery</b>	Li-ion
<b>Battery power</b>	417,6 - 630 Wh
<b>Voltage</b>	36 V
<b>Range</b>	up to 140 km
<b>Cells brand</b>	LG / Greenway

<b>Display</b>	Monochromatic LCD
<b>Display brand</b>	Ecobike
<b>Display model</b>	C300U









- A** 600.3 mm
- B** 161 mm
- C** 432 mm
- D** 1105.7 mm
- E** 72.5°
- F** 70°



ECOBIKE CITY  
**Traffic Beige**



Discover more

-  **23.8 kg**  
Weight
-  **250 W**  
Motor power
-  **417.6 - 630 Wh**  
Battery capacity
-  **140 km**  
Maximum range
-  **26"**  
Wheel
-  **17"**  
Frame

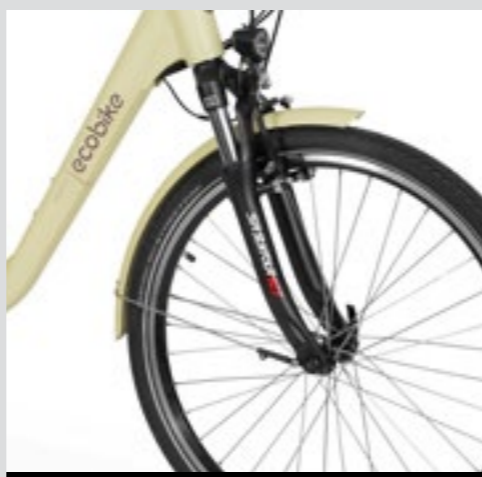
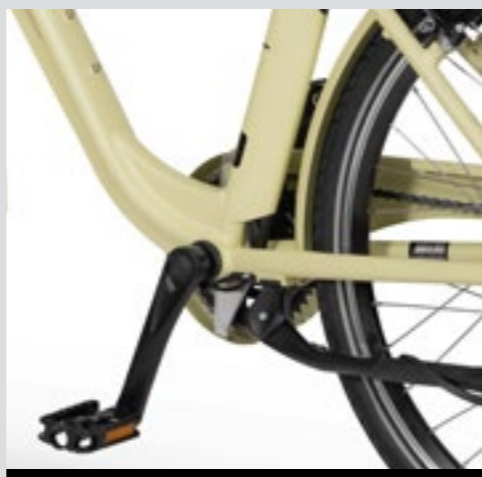
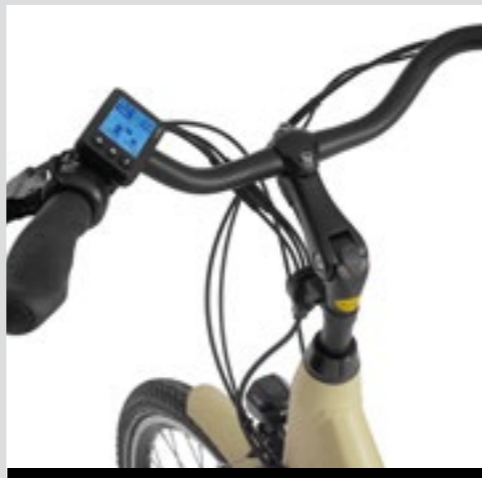

Specification

<b>Frame</b>	17" hydroformed aluminium
<b>Fork</b>	SunTour SF14 CR8V P travel 63 mm
<b>Wheel</b>	26" reinforced three-chambered rims / Sapim spokes
<b>Tires</b>	26" x 1.75 Impac StreetPac / Rubena Flash
<b>Derailleur front</b>	-
<b>Derailleur rear</b>	Shimano Altus 7-speed
<b>Shifter</b>	Shimano Tourney Revo 7-speed
<b>Brakes</b>	Promax TX 117 V-brakes
<b>Saddle</b>	Selle Royal Lookin Basic
<b>Handlebar</b>	Promax 600 mm 25.4
<b>Handlebar stem</b>	Promax 105 mm
<b>Freewheel / Cassette</b>	Shimano MF-TZ500 14-28T 7-speed
<b>Chain</b>	KMC z7
<b>Crank</b>	Prowheel 42T
<b>Front hub</b>	Joytech 751DSE
<b>Rear hub</b>	Motor
<b>Bottom bracket</b>	Feimin FP-B902W
<b>Pedals</b>	WELLGO
<b>Grip</b>	Velo VLG 519AD2
<b>Front light</b>	Spaninga Kendo XE
<b>Rear light</b>	Spaninga RL1900XE DC36V E-BIKE
<b>Seat post</b>	Promax 27.2 / 350 mm
<b>Max load</b>	125 kg
<b>Weight</b>	23.8 kg

<b>Type of motor</b>	Rear hub motor
<b>Brand of motor</b>	Bafang
<b>Model of motor</b>	SWX02
<b>Nominal power of motor</b>	250 W

<b>Torque</b>	45 N.m
<b>Voltage</b>	36 V

<b>Type of battery</b>	Li-ion
<b>Battery power</b>	417,6 - 630 Wh
<b>Voltage</b>	36 V
<b>Range</b>	up to 140 km
<b>Cells brand</b>	LG / Greenway

<b>Display</b>	Monochromatic LCD
<b>Display brand</b>	Ecobike
<b>Display model</b>	C300U



- A** 600.3 mm
- B** 161 mm
- C** 432 mm
- D** 1105.7 mm
- E** 72.5°
- F** 70°



ECOBIKE CITY

# Traffic Navy Blue



Discover more

- 23.8 kg**  
Weight
- 250 W**  
Motor power
- 417.6 - 630 Wh**  
Battery capacity
- 140 km**  
Maximum range
- 26"**  
Wheel
- 17"**  
Frame

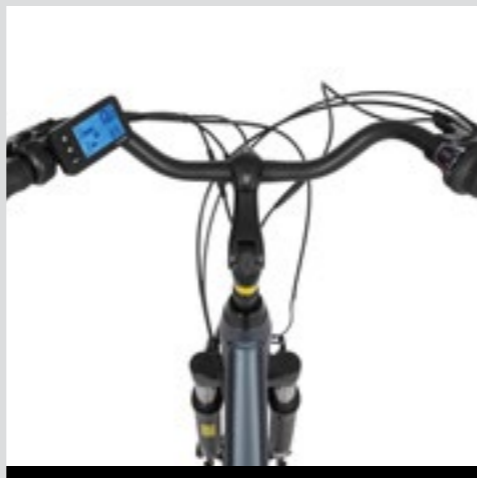
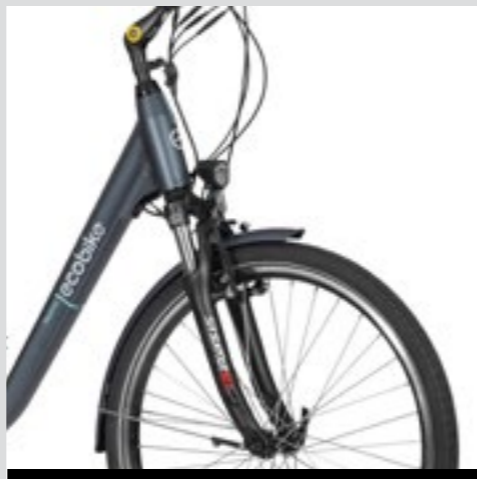

Specification

E-bike system

<b>Frame</b>	17" hydroformed aluminium
<b>Fork</b>	SunTour SF14 CR8V P travel 63 mm
<b>Wheel</b>	26" reinforced three-chambered rims / Sapim spokes
<b>Tires</b>	26" x 1.75 Impac StreetPac / Rubena Flash
<b>Derailleur front</b>	-
<b>Derailleur rear</b>	Shimano Altus 7-speed
<b>Shifter</b>	Shimano Tourney Revo 7-speed
<b>Brakes</b>	Promax TX 117 V-brakes
<b>Saddle</b>	Selle Royal Lookin Basic
<b>Handlebar</b>	Promax 600 mm 25.4
<b>Handlebar stem</b>	Promax 105 mm
<b>Freewheel / Cassette</b>	Shimano MF-TZ500 14-28T 7-speed
<b>Chain</b>	KMC z7
<b>Crank</b>	Prowheel 42T
<b>Front hub</b>	Joytech 751DSE
<b>Rear hub</b>	Motor
<b>Bottom bracket</b>	Feimin FP-B902W
<b>Pedals</b>	WELLGO
<b>Grip</b>	Velo VLG 519AD2
<b>Front light</b>	Spaninga Kendo XE
<b>Rear light</b>	Spaninga RL1900XE DC36V E-BIKE
<b>Seat post</b>	Promax 27.2 / 350 mm
<b>Max load</b>	125 kg
<b>Weight</b>	23.8 kg

<b>Type of motor</b>	Rear hub motor
<b>Brand of motor</b>	Bafang
<b>Model of motor</b>	SWX02
<b>Nominal power of motor</b>	250 W

<b>Torque</b>	45 N.m
<b>Voltage</b>	36 V

<b>Type of battery</b>	Li-ion
<b>Battery power</b>	417,6 - 630 Wh
<b>Voltage</b>	36 V
<b>Range</b>	up to 140 km
<b>Cells brand</b>	LG / Greenway

<b>Display</b>	Monochromatic LCD
<b>Display brand</b>	Ecobike
<b>Display model</b>	C300U









- A** 600.3 mm
- B** 161 mm
- C** 432 mm
- D** 1105.7 mm
- E** 72.5°
- F** 70°



ECOBIKE CITY  
**Traffic Mint**



Discover more

-  **24.1 kg**  
Weight
-  **250 W**  
Motor power
-  **417.6 - 630 Wh**  
Battery capacity
-  **140 km**  
Maximum range
-  **28"**  
Wheel
-  **17"**  
Frame

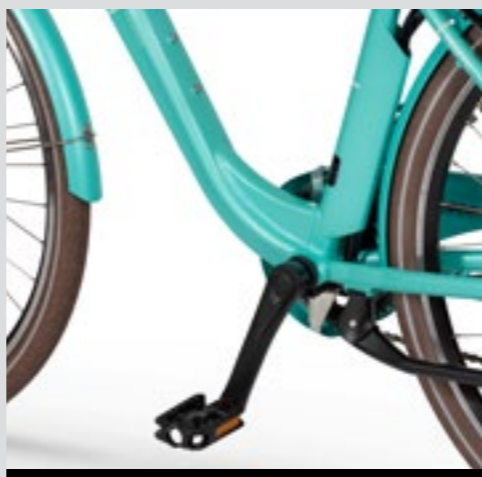
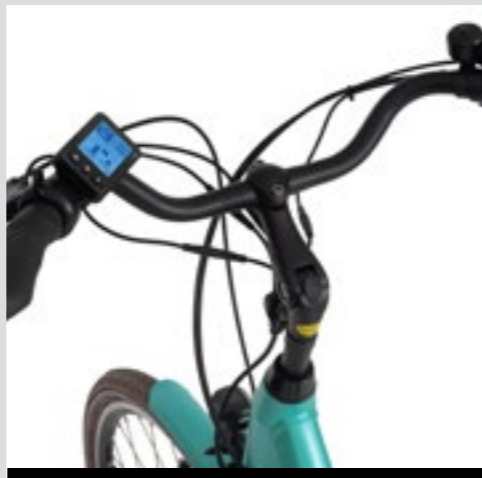

Specification

<b>Frame</b>	17" hydroformed aluminium
<b>Fork</b>	SunTour SF14 CR8V P travel 63 mm
<b>Wheel</b>	28" reinforced three-chambered rims / Sapim spokes
<b>Tires</b>	28" x 1.75 Rubena Flash Brown
<b>Derailleur front</b>	-
<b>Derailleur rear</b>	Shimano Altus 7-speed
<b>Shifter</b>	Shimano Tourney Revo 7-speed
<b>Brakes</b>	Promax TX 117 V-brakes
<b>Saddle</b>	Selle Royal Lookin Basic
<b>Handlebar</b>	Promax 600 mm 25.4
<b>Handlebar stem</b>	Promax 105 mm
<b>Freewheel / Cassette</b>	Shimano MF-TZ500 14-28T 7-speed
<b>Chain</b>	KMC z7
<b>Crank</b>	Prowheel 42T
<b>Front hub</b>	Joytech 751DSE
<b>Rear hub</b>	Motor
<b>Bottom bracket</b>	Feimin FP-B902W
<b>Pedals</b>	WELLGO
<b>Grip</b>	Velo VLG 519AD2
<b>Front light</b>	Spaninga Kendo XE
<b>Rear light</b>	Spaninga RL1900XE DC36V E-BIKE
<b>Seat post</b>	Promax 27.2 / 350 mm
<b>Max load</b>	125 kg
<b>Weight</b>	24.1 kg

<b>Type of motor</b>	Rear hub motor
<b>Brand of motor</b>	Bafang
<b>Model of motor</b>	SWX02
<b>Nominal power of motor</b>	250 W

<b>Torque</b>	45 N.m
<b>Voltage</b>	36 V

<b>Type of battery</b>	Li-ion
<b>Battery power</b>	417,6 - 630 Wh
<b>Voltage</b>	36 V
<b>Range</b>	up to 140 km
<b>Cells brand</b>	LG / Greenway

<b>Display</b>	Monochromatic LCD
<b>Display brand</b>	Ecobike
<b>Display model</b>	



- A** 600.3 mm
- B** 161 mm
- C** 432 mm
- D** 1105.7 mm
- E** 72.5°
- F** 70°



E-bike system

ECOBIKE CITY

# Traffic Blue



Discover more

- 24.3 kg**  
Weight
- 250 W**  
Motor power
- 417.6 - 630 Wh**  
Battery capacity
- 140 km**  
Maximum range
- 28"**  
Wheel
- 19"**  
Frame

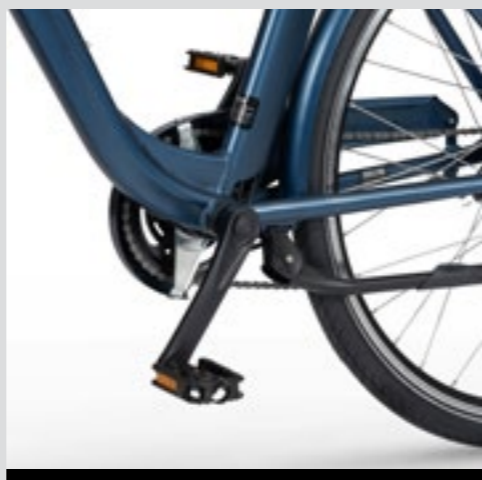
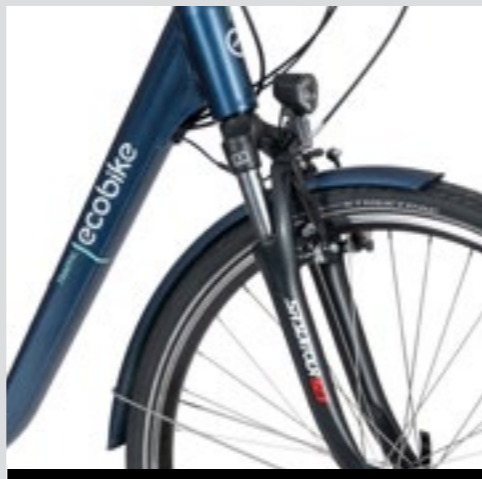

Specification

<b>Frame</b>	19" hydroformed aluminium
<b>Fork</b>	SunTour SF14 CR8V P travel 63 mm
<b>Wheel</b>	28" reinforced three-chambered rims / Sapim spokes
<b>Tires</b>	28" x 1.75 Impac StreetPac / Rubena Flash
<b>Derailleur front</b>	-
<b>Derailleur rear</b>	Shimano Altus 7-speed
<b>Shifter</b>	Shimano Tourney Revo 7-speed
<b>Brakes</b>	Promax TX 117 V-brakes
<b>Saddle</b>	Selle Royal Lookin Basic
<b>Handlebar</b>	Promax 600 mm 25.4
<b>Handlebar stem</b>	Promax 105 mm
<b>Freewheel / Cassette</b>	Shimano MF-TZ500 14-28T 7-speed
<b>Chain</b>	KMC z7
<b>Crank</b>	Prowheel 42T
<b>Front hub</b>	Joytech 751DSE
<b>Rear hub</b>	Motor
<b>Bottom bracket</b>	Feimin FP-B902W
<b>Pedals</b>	WELLGO
<b>Grip</b>	Velo VLG 519AD2
<b>Front light</b>	Spaninga Kendo XE
<b>Rear light</b>	Spaninga RL1900XE DC36V E-BIKE
<b>Seat post</b>	Promax 27.2 / 350 mm
<b>Max load</b>	125 kg
<b>Weight</b>	24.3 kg

<b>Type of motor</b>	Rear hub motor
<b>Brand of motor</b>	Bafang
<b>Model of motor</b>	SWX02
<b>Nominal power of motor</b>	250 W

<b>Torque</b>	45 N.m
<b>Voltage</b>	36 V

<b>Type of battery</b>	Li-ion
<b>Battery power</b>	417,6 - 630 Wh
<b>Voltage</b>	36 V
<b>Range</b>	up to 140 km
<b>Cells brand</b>	LG / Greenway

<b>Display</b>	Monochromatic LCD
<b>Display brand</b>	Ecobike
<b>Display model</b>	C300U



- A** 600.4 mm
- B** 161 mm
- C** 482 mm
- D** 1105.7 mm
- E** 72.5°
- F** 70°



ECOBIKE CITY

# Traffic M Black



Discover more

- 24.5 kg**  
Weight
- 250 W**  
Motor power
- 417.6 - 630 Wh**  
Battery capacity
- 140 km**  
Maximum range
- 28"**  
Wheel
- 19"**  
Frame



Specification

<b>Frame</b>	19" hydroformed aluminum
<b>Fork</b>	SunTour SF14-CR8V-P travel 63 mm
<b>Wheel</b>	28" reinforced three-chambered rims / Sapim spokes
<b>Tires</b>	28" x 1.75 Impac StreetPac / Rubena Flash
<b>Derailleur front</b>	-
<b>Derailleur rear</b>	Shimano Altus 7 speed
<b>Shifter</b>	Shimano Tourney Revo 7 speed
<b>Brakes</b>	Promax TX-117 V-brakes
<b>Saddle</b>	Selle Royal Lookin Basic
<b>Handlebar</b>	Promax 700 mm 31.8
<b>Handlebar stem</b>	UNO 180 mm
<b>Freewheel / Cassette</b>	Shimano MF-TZ500 14-28T 7 speed
<b>Chain</b>	KMC
<b>Crank</b>	Prowheel 42T
<b>Front hub</b>	Joytech 751DSE
<b>Rear hub</b>	Motor
<b>Bottom bracket</b>	Feimin FP-B902W
<b>Pedals</b>	WELLGO
<b>Grip</b>	Velo VLG-519AD2
<b>Front light</b>	Spaninga Kendo XE
<b>Rear light</b>	Spaninga RL1900XE DC36V E-BIKE
<b>Seat post</b>	Promax 27.2 / 350 mm
<b>Max load</b>	125 kg
<b>Weight</b>	22.1 kg

<b>Type of motor</b>	Rear hub motor
<b>Brand of motor</b>	Bafang
<b>Model of motor</b>	SWX02
<b>Nominal power of motor</b>	250 W

<b>Torque</b>	45 N.m
<b>Voltage</b>	36 V

<b>Type of battery</b>	Li-ion
<b>Battery power</b>	417,6 - 630 Wh
<b>Voltage</b>	36 V
<b>Range</b>	up to 140 km
<b>Cells brand</b>	LG / Greenway

<b>Display</b>	LCD monochromatic
<b>Display brand</b>	Ecobike
<b>Display model</b>	C300U

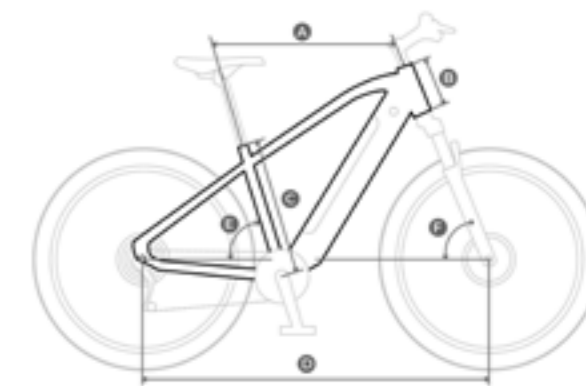

- A 600.4 mm
- B 161 mm
- C 482 mm
- D 1105.7 mm
- E 72.5°
- F 70°



E-bike system



# CITY / FOLDING

Folding electric bikes are an integral part of the Ecobike City collection. We pay special attention to their weight, ease of folding, and transport.









ECOBIKE CITY / FOLDING

# Even Black



Discover more

-  **22 kg**  
Weight
-  **250 W**  
Motor power
-  **522 – 630 Wh**  
Battery capacity
-  **140 km**  
Maximum range
-  **20"**  
Wheel
-  **15.5"**  
Frame

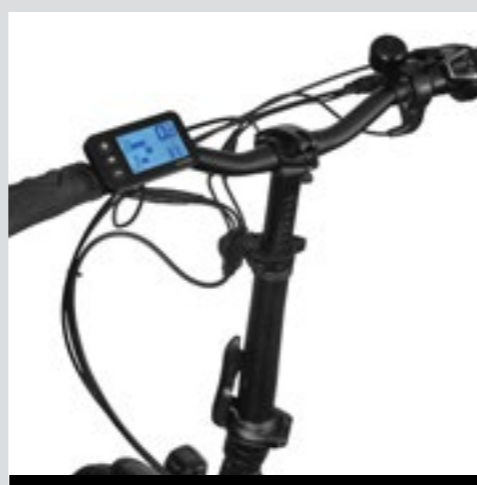
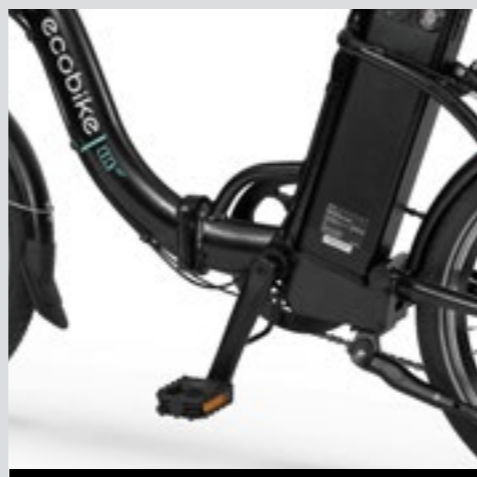

Specification

<b>Frame</b>	15.5" hydroformed aluminium
<b>Fork</b>	RST CARVE P 20 travel 50 mm
<b>Wheel</b>	20" reinforced three-chambered rims / Sapim spokes
<b>Tires</b>	20" x 2.0 Schwalbe Big Apple
<b>Derailleur front</b>	-
<b>Derailleur rear</b>	Shimano Tourney 6-speed
<b>Shifter</b>	Shimano Tourney Revo 6-speed
<b>Brakes</b>	Promax TX 117 V-brakes
<b>Saddle</b>	Selle Royal Freeway
<b>Handlebar</b>	Promax 640 mm 25.4
<b>Handlebar stem</b>	Zoom 9° / 70 mm
<b>Freewheel / Cassette</b>	Shimano MF-TZ500 14-28T 6-speed
<b>Chain</b>	KMC
<b>Crank</b>	Topwheel 52T
<b>Front hub</b>	Joytech 751DSE
<b>Rear hub</b>	Motor
<b>Bottom bracket</b>	Feimin FP-B917 9H
<b>Pedals</b>	VP
<b>Grip</b>	Velo VLG 709-2AD3
<b>Front light</b>	Spaninga Kendo XE
<b>Rear light</b>	Spaninga RL1900XE DC36V E-BIKE
<b>Seat post</b>	Zoom 27.2 / 350 mm
<b>Max load</b>	125 kg
<b>Weight</b>	22 kg

<b>Type of motor</b>	Rear hub motor
<b>Brand of motor</b>	Bafang
<b>Model of motor</b>	SWXH2
<b>Nominal power of motor</b>	250 W

<b>Torque</b>	32 N.m
<b>Voltage</b>	36 V

<b>Type of battery</b>	Li-ion
<b>Battery power</b>	522 – 630 Wh
<b>Voltage</b>	36 V
<b>Range</b>	up to 140 km
<b>Cells brand</b>	LG / Greenway

<b>Display</b>	Monochromatic LCD
<b>Display brand</b>	Ecobike
<b>Display model</b>	C300S

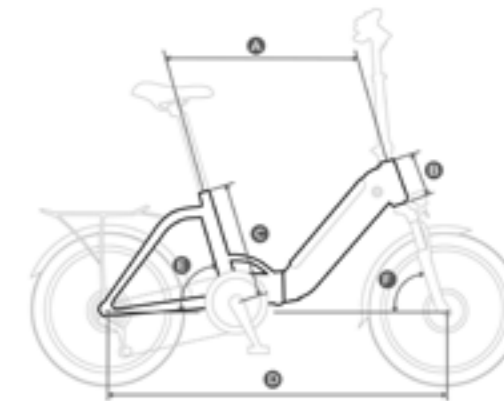

- A** 568.9 mm
- B** 140 mm
- C** 275 mm
- D** 1071.7 mm
- E** 72.6°
- F** 70.9°





E-bike system

ECOBIKE CITY / FOLDING

# Even White



Discover more

-  **22 kg**  
Weight
-  **250 W**  
Motor power
-  **522 – 630 Wh**  
Battery capacity
-  **140 km**  
Maximum range
-  **20"**  
Wheel
-  **15.5"**  
Frame

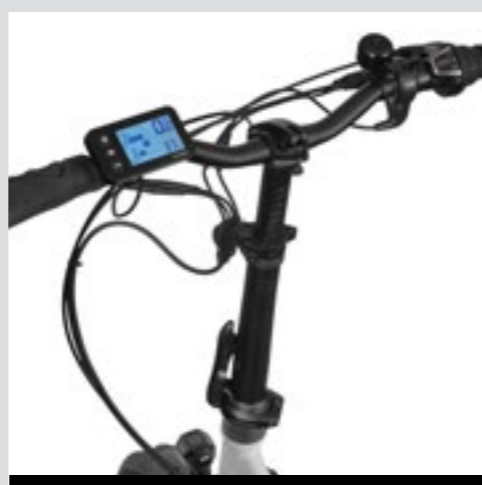
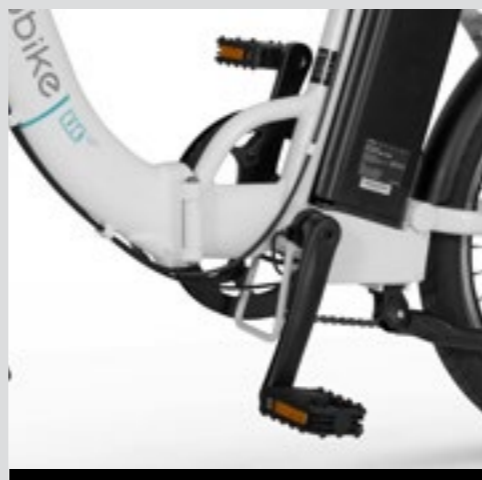
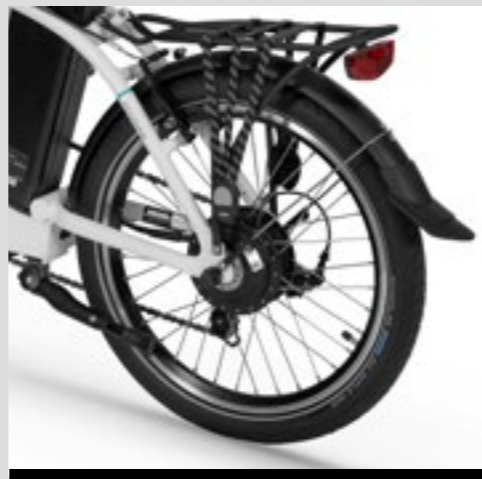

- A 568.9 mm
- B 140 mm
- C 275 mm
- D 1071.7 mm
- E 72.6°
- F 70.9°

## Specification

<b>Frame</b>	15.5" hydroformed aluminium
<b>Fork</b>	RST CARVE P 20 travel 50 mm
<b>Wheel</b>	20" reinforced three-chambered rims / Sapim spokes
<b>Tires</b>	20" x 2.0 Schwalbe Big Apple
<b>Derailleur front</b>	-
<b>Derailleur rear</b>	Shimano Tourney 6-speed
<b>Shifter</b>	Shimano Tourney Revo 6-speed
<b>Brakes</b>	Promax TX 117 V-brakes
<b>Saddle</b>	Selle Royal Freeway
<b>Handlebar</b>	Promax 640 mm 25.4
<b>Handlebar stem</b>	Zoom 9° / 70 mm
<b>Freewheel / Cassette</b>	Shimano MF-TZ500 14-28T 6-speed
<b>Chain</b>	KMC
<b>Crank</b>	Topwheel 52T
<b>Front hub</b>	Joytech 751DSE
<b>Rear hub</b>	Motor
<b>Bottom bracket</b>	Feimin FP-B917 9H
<b>Pedals</b>	VP
<b>Grip</b>	Velo VLG 709-2AD3
<b>Front light</b>	Spaninga Kendo XE
<b>Rear light</b>	Spaninga RL1900XE DC36V E-BIKE
<b>Seat post</b>	Zoom 27.2 / 350 mm
<b>Max load</b>	125 kg
<b>Weight</b>	22 kg

<b>Type of motor</b>	Rear hub motor
<b>Brand of motor</b>	Bafang
<b>Model of motor</b>	SWXH2
<b>Nominal power of motor</b>	250 W

<b>Torque</b>	32 N.m
<b>Voltage</b>	36 V

<b>Type of battery</b>	Li-ion
<b>Battery power</b>	522 – 630 Wh
<b>Voltage</b>	36 V
<b>Range</b>	up to 140 km
<b>Cells brand</b>	LG / Greenway

<b>Display</b>	Monochromatic LCD
<b>Display brand</b>	Ecobike
<b>Display model</b>	C300S

## E-bike system





ECOBIKE CITY / FOLDING

# Even Ocean Blue



Discover more

-  **22 kg**  
Weight
-  **250 W**  
Motor power
-  **522 – 630 Wh**  
Battery capacity
-  **140 km**  
Maximum range
-  **20"**  
Wheel
-  **15.5"**  
Frame

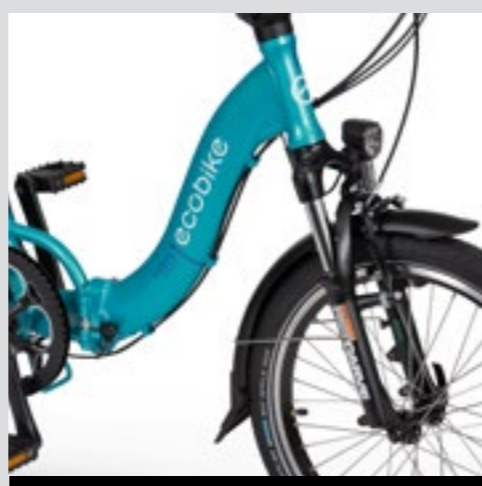
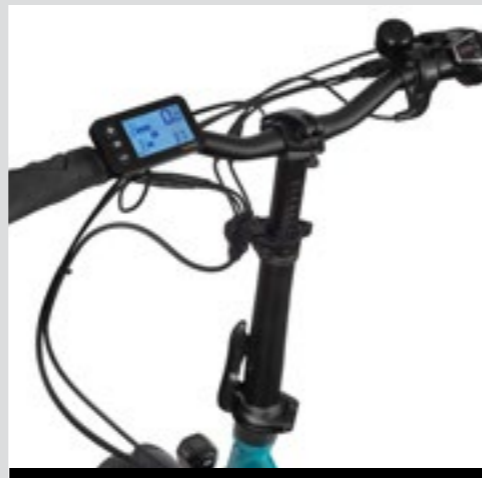

Specification

<b>Frame</b>	15.5" hydroformed aluminium
<b>Fork</b>	RST CARVE P 20 travel 50 mm
<b>Wheel</b>	20" reinforced three-chambered rims / Sapim spokes
<b>Tires</b>	20" x 2.0 Schwalbe Big Apple
<b>Derailleur front</b>	-
<b>Derailleur rear</b>	Shimano Tourney 6-speed
<b>Shifter</b>	Shimano Tourney Revo 6-speed
<b>Brakes</b>	Promax TX 117 V-brakes
<b>Saddle</b>	Selle Royal Freeway
<b>Handlebar</b>	Promax 640 mm 25.4
<b>Handlebar stem</b>	Zoom 9° / 70 mm
<b>Freewheel / Cassette</b>	Shimano MF-TZ500 14-28T 6-speed
<b>Chain</b>	KMC
<b>Crank</b>	Topwheel 52T
<b>Front hub</b>	Joytech 751DSE
<b>Rear hub</b>	Motor
<b>Bottom bracket</b>	Feimin FP-B917 9H
<b>Pedals</b>	VP
<b>Grip</b>	Velo VLG 709-2AD3
<b>Front light</b>	Spaninga Kendo XE
<b>Rear light</b>	Spaninga RL1900XE DC36V E-BIKE
<b>Seat post</b>	Zoom 27.2 / 350 mm
<b>Max load</b>	125 kg
<b>Weight</b>	22 kg

<b>Type of motor</b>	Rear hub motor
<b>Brand of motor</b>	Bafang
<b>Model of motor</b>	SWXH2
<b>Nominal power of motor</b>	250 W

<b>Torque</b>	32 N.m
<b>Voltage</b>	36 V

<b>Type of battery</b>	Li-ion
<b>Battery power</b>	522 – 630 Wh
<b>Voltage</b>	36 V
<b>Range</b>	up to 140 km
<b>Cells brand</b>	LG / Greenway

<b>Display</b>	Monochromatic LCD
<b>Display brand</b>	Ecobike
<b>Display model</b>	C300S



- A** 568.9 mm
- B** 140 mm
- C** 275 mm
- D** 1071.7 mm
- E** 72.6°
- F** 70.9°



ECOBIKE CITY / FOLDING

# Rhino



**23.6 kg**

Weight



**250 W**

Motor power



**522 – 630 Wh**

Battery capacity



**140 km**

Maximum range



**20"**

Wheel



**15.5"**

Frame



Discover more



Specification

<b>Frame</b>	15.5" hydroformed aluminium
<b>Fork</b>	RST CARVE-D-20 travel 50 mm
<b>Wheel</b>	20" reinforced three-chambered rims / Sapim spokes
<b>Tires</b>	20" x 2.0 Schwalbe Big Apple
<b>Derailleur front</b>	-
<b>Derailleur rear</b>	Shimano Tourney 6-speed
<b>Shifter</b>	Shimano Tourney Revo 6-speed
<b>Brakes</b>	Tektro MD M300 mechanical
<b>Saddle</b>	Selle Royal Freeway
<b>Handlebar</b>	Promax 640 mm 25.4
<b>Handlebar stem</b>	Zoom 9° / 70 mm
<b>Freewheel / Cassette</b>	Shimano MF-TZ500 14-28T 6-speed
<b>Chain</b>	KMC
<b>Crank</b>	Prowheel 46T
<b>Front hub</b>	KT-SN6F
<b>Rear hub</b>	Motor
<b>Bottom bracket</b>	Feimin FP-B902W
<b>Pedals</b>	VP
<b>Grip</b>	Velo VLG 709-2AD3
<b>Front light</b>	Spaninga Kendo XE
<b>Rear light</b>	Spaninga RL1900XE DC36V E-BIKE
<b>Seat post</b>	Promax 30.4 / 350 mm
<b>Max load</b>	125 kg
<b>Weight</b>	23.6 kg

<b>Type of motor</b>	Rear hub motor
<b>Brand of motor</b>	Bafang
<b>Model of motor</b>	SWXH2
<b>Nominal power of motor</b>	250 W

<b>Torque</b>	32 N.m
<b>Voltage</b>	36 V

<b>Type of battery</b>	Li-ion
<b>Battery power</b>	522 – 630 Wh
<b>Voltage</b>	36 V
<b>Range</b>	up to 140 km
<b>Cells brand</b>	LG / Greenway

<b>Display</b>	Monochromatic LCD
<b>Display brand</b>	Ecobike
<b>Display model</b>	C300U

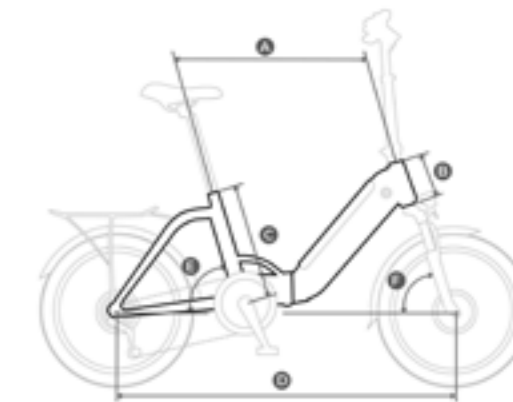

<b>A</b>	619.9 mm
<b>B</b>	135 mm
<b>C</b>	365 mm
<b>D</b>	1093.6 mm
<b>E</b>	73°
<b>F</b>	72.5°





**#READY  
TO RIDE**



**ecobike**





# CELEBRATING 15 YEARS TOGETHER!

Ecobike is one of the first e-bike manufacturers in Europe. We have a wide experience in electric bikes manufacturing. Our e-bikes are sold both under our own brand Ecobike and other well-established European brands. We have gained trust across the entire European continent.

We recently established a state-of-the-art warehouse in the heart of Wrocław, a city renowned as Poland's IT and automotive Silicon Valley. Our Ecobike headquarters are much more than a modern factory and warehouse with specialized services - it's also a hub for innovation, where we create and test prototype solutions that advance the whole e-bicycle industry.

## GROWING NETWORK OF 300+ DEALERS



## What makes Ecobike special?

### CRAFTED IN EU

Our bicycles are crafted with care in Poland, using only world-class components. Ecobike Team draws on years of experience to assemble each e-bike with precision and attention to detail.

### BEST SERVICE EVER

Professional service is key to keeping your bike in optimal condition. Ecobike provides top-notch repair services to keep your bike running smoothly.

### THE PERFECT CHOICE

Ecobike e-bikes have an ideal price to quality ratio. The sleek and modern design of our e-bikes also make them a stylish option for riders of all ages.

## RELIABLE TECHNOLOGIES



SHIMANO

SRAM

SR SUNTOUR

spanninga



PROMAX



BAFANG

Greenway

ANANDA

# PROVEN

Bikes are all about the equipment. Ecobike e-bikes combine reliable parts from recognized manufacturers with durable electric motors and long-lasting batteries.

Our e-bikes work in every situation. Travelling through Europe and Asia? Or maybe 14,000 kilometers around the world? Our customers have already proved it!

# TO WIN



We have won numerous awards during prestigious bike fairs. Our e-bikes have been recognized worldwide, earning the highest ratings in customer reviews and tests.



CE

All products are manufactured in accordance to EU regulations and restrictive standards EN15194 / EPAC / ISO4210-2





## Headquarters & factory

Wschodnia 12  
55-330 Źródła, Poland

☎ +48 71 307 04 02  
@ b2b@ecobike.pl  
🖱 www.ecobike.pl

## Company data

Osieniecka 108  
54-530 Wrocław, Poland

VAT ID: PL8943124748  
KRS: 0000715499  
REGON: 369401457

Copyright © Ecobike Ltd.  
All rights reserved

The contents of this catalog do not constitute an offer according to the Civil Code. We put our best effort to ensure that the information provided is complete and up-to-date, however, we reserve the right to update product specifications and to make unintentional print errors.

